



# Flow Characterization Rheometer with RETURN FCRR - TP117B

# Operating Manual



## Table of Contents

### I. General Information and Operation

- SAFETY INSTRUCTIONS
- IMPORTANT INTRINSICALLY SAFE INFORMATION
- SYSTEM DESCRIPTION
- EQUIPMENT LIST
- GENERAL SPECIFICATIONS
- THEORY OF OPERATION
- RHEOMETER OPERATION
- RECOMMENDED SERVICE SCHEDULE

### II. Unpacking and Installation

### III. RCU Technical Information

- STATE TRANSITION DIAGRAM
- SOFTWARE OPERATION
- ALARM/FAULT LOGIC
- CPU OK INDICATOR
- CPU MEMORY RESET
- HARDWARE DESCRIPTION

### IV. Local Operator Display

- ENVIRONMENTAL CONSIDERATIONS
- SECURITY
- DISPLAYS OVERVIEW
  - Start-up screen
  - Main Screen and Menu Screens
  - Process Setpoints
  - Equation Constants
  - Operator Setup
  - Recipes
  - Process Status
  - Equation Results
  - Alarm Status
  - Trending



## Table of Contents

- Temperature Calibration
- Pressure Calibration
- Analog I/O Calibration
- Machine Configuration
- Manual Purge
- Error Log
- Diagnostics
- IO Status
- Machine Hours
- Set IP Address
- LOCAL DISPLAY SYSTEM OPERATIONS
- DISPLAY CONTRAST
- TOUCH SCREEN CALIBRATION
- RESETTING DISPLAY SYSTEMS DATA
- V. Rheometer Technical Manual
  - INTRODUCTION
  - GENERAL OPERATION
  - MAINTENANCE
    - Capillary Removal / Replacement
    - Metering Pump Replacement
    - Transducer Replacement
    - Tachometer Replacement
    - Gear Reducer Maintenance
    - Flow Block Leak Inspection
  - TROUBLESHOOTING
- VI. Calibration
  - INTRODUCTION
  - EQUIPMENT REQUIRED TO CALIBRATE SYSTEM
  - PRESSURE TRANSDUCER CALIBRATION
  - MOTOR SPEED CONTROLLER ADJUSTMENTS
  - STRIP CHART (4-20 MA) OUTPUT LEVEL TEST
  - TEMPERATURE CALIBRATION







I. General Information and Operation

**SAFETY INSTRUCTIONS**

All safety instructions must be heeded and observed. Non-observance of safety instructions may cause damage to life and health of persons, environmental damage and/or extensive damage to property. Observing the safety instructions included in the operating instructions will help to avoid dangers, to operate the installation profitably and to secure the full use of the product.

**Warnings and Danger Symbols**

General safety instructions concerning the activities are given at the beginning of the relevant chapter. Special safety instructions concerning the individual steps of action will be given together with the corresponding step of action. The following pictographs are used in the present operating instructions

 Danger	This symbol indicates that death, <b>serious</b> bodily injuries or <b>considerable</b> damage to property <b>will</b> occur if the corresponding safety measures are not observed!
 Warning	This symbol indicates that death, <b>serious</b> bodily injuries or <b>considerable</b> damage to property <b>may</b> occur if the corresponding safety measures are not observed!
 Caution	This symbol indicates that death, <b>minor</b> bodily injuries or <b>minor</b> damage to property <b>may</b> occur if the corresponding safety measures are not observed!
	This symbol indicates that special danger to the life and health of persons will be given due to electric potential!
	This symbol indicates that special danger to the life and health of persons will be given due to hot surfaces!

	<p>This symbol indicates that sufficient personal protective equipment must be worn when working with the Dynisco component. The type of personal protective equipment will be defined in detail!</p>
	<p>This symbol signals user hints and other special information, which may be useful. This symbol does not signalise safety instructions!</p>

Please also note that a safety symbol may never substitute the text of a safety instruction - therefore, the text of a safety instruction must always be read completely!

### SAFETY SUMMARY

The following are recommended safety precautions unrelated to any specific procedures in this manual and therefore do not appear elsewhere. Personnel must understand and apply them as appropriate during all phases of operation and maintenance. **IN ALL CASES, BE PRUDENT.**

Keep away from live circuits

	<p>Do not replace components or make adjustments inside equipment with power turned on. To avoid injuries, always remove power and discharge and ground a circuit before touching it. When making electrical connections, the services of a qualified electrician must be employed. Contact with live electrical circuits can cause serious personal injury or death. Be sure no circuits are energized during installation, connection or removal of any electrical cables or lines.</p>
	<p>Wear protective clothing (gloves, apron, goggles, etc.) approved for the materials and tools being used.</p>
	<p>Provide ventilation to remove heat and noxious odors and to prevent the accumulation of asphyxiates such as nitrogen gas.</p>
	<p>Keep hands away from hot surfaces and materials. Contact with hot surfaces or materials can cause blistering and third degree burns. Wear approved, clean, thermally insulated gloves when handling these components. Should injury occur, immerse injured area in cold water and get immediate medical attention.</p>





The Flow Characterization Rheometer (FCR) was planned and constructed taking into consideration a hazard analysis and after having carefully selected the harmonised standards as well as further technical specifications. Thus, the Dynisco component conforms to the state of the art technology and ensures a maximum of safety.

In practical operation, this safety can, however, be achieved only if all necessary measures are taken. The obligation of the plant operator to exercise due care includes planning these measures and supervising their execution.

Especially, the operator has to ensure that

- The Dynisco component will be used only in accordance with the intended purpose.
- The Dynisco component will be operated in a flawless, functionally efficient condition and that, in particular, the functional efficiency of the safety devices will be checked at regular intervals.
- The necessary personal protective equipment for the operating, maintenance, and service personnel will be available and used by them.
- The operating instructions are always available completely and fully legibly at the installation location of the Dynisco component. It must be guaranteed that all persons who have to work with the Dynisco component can consult the operating instructions at any time.
- Only sufficiently qualified and authorized personnel will operate, maintain, and repair the Dynisco component.
- Instructions concerning all relevant questions of industrial safety and environmental protection will regularly be given to the personnel, and that these persons will know and understand the operating instructions and, particularly, the safety instructions contained.
- All safety and warning instructions, attached to the Dynisco component, will not be removed and will remain fully legible.
- The service instructions in accordance with the industrial safety legislation and the ordinance for the use of work materials will have to be made available as a supplement to the operating instructions.

Obligation of the personnel to exercise due care

The Flow Characterization Rheometer (FCR) may only be operated by persons trained, instructed and authorized to do so. These persons must know the operating instructions and act accordingly. The respective competences of the staff must be clearly determined.

The following work described in the operating instructions may be carried out by qualified persons only:

- Assembly
- Start-Up
- Operation
- Servicing

Especially, the staff must to ensure that:

- Operating personnel to be instructed to work with the Dynisco component are supervised by an experienced person.
- All persons operating or maintaining the Dynisco component have read the operating instructions and confirm by their signature that they understood the instructions.
- Unauthorized persons must not stay in the working area of the Dynisco component.
- The working area must be posted with the hazards of hot and movable parts.



- Additionally to the operating instructions and service instructions may need clarified within the meaning of the observed industrial safety legislation and ordinances for the use of the machine, tools, and work materials.
- In case of a malfunction, the operator or the supervisors must be informed immediately.
- The necessary and approved personal protective equipment (PPE) for the operating, maintenance, and service personnel must be used.

### IMPORTANT INFORMATION WHEN INSTALLING IN A CLASS I, DIVISION 2 HAZARDOUS LOCATION

This information is specifically for equipment marked Class I, Division 2, Groups C & D. Equipment so marked is suitable for use in Class I, Division 2 Groups C & D or non-hazardous locations only.

**WARNING: EXPLOSION HAZARD—SUBSTITUTION OF COMPONENTS MAY IMPAIR SUITABILITY FOR CLASS I, DIVISION 2, GROUPS C & D RATING.**

Equipment suitable for Class I, Division 2 is equipped with a BEBCO EPS cabinet pressurizing system. The requirements for this pressurizing system are:

- Operating Temperature: -20°F to 120°F (-30°C to 50°C)
- Operating Pressure: 80 PSI to 120 PSI Maximum
- Capacity & Filtration: 3.8 Oz. @ 40 Microns
- Gas Supply: Clean Air
- Exchange Pressure: 3" to 5"
- Exchange Flow Rate: 10 SCFM
- Exchange Time: 1 Minute / 2.5 Cubic Feet (RCU cabinet is 7.3 ft3)

NOTE: A minimum purge time of 5 minutes is required before operation.

There are no switching components in the rheometer head, therefore pressurization of the Rheometer head is not required.

If the cabinet seal is broken so that the internal pressure cannot be maintained above 0.1" H2O, the control system will detect this failure, shut the control outputs off and set an alarm contact.

The alarm contact should be wired to an external alarm system that is located in a constantly attended area.

The temperature of the incoming material must not exceed 100°C (212°F).



## SYSTEM DESCRIPTION

The DYNISCO Flow Characterization Return Stream Rheometer (FCRR) is a PLC based rheometer designed specifically for the polymer process industry to make dual rheological measurements on the general class of thermoflow polymers, blends and variations as well as other thermoflow materials.

The rheometer performs dual capillary rheology at a test temperature on a small sample stream of polymer melt taken from the process extruder. After analysis, the polymer sample is returned to the process. Extruder pressure is required to feed the rheometer metering pump. The rheometer metering pump splits the flow into two identical streams.

The material is pumped through two test cavities, each having a pressure transducer and a capillary orifice. The rheometer can be set up to provide a constant pressure test (ASTM, CIL, etc.), measuring the flow rate and calculating the "Melt Flow" units. Alternatively, the rheometer can be set up to provide a constant flow rate test, measuring the pressure drop across a capillary and calculating the "Viscosity" units. A third pressure transducer is located in a common passage for both flow streams and the discharge back to the process. This third transducer monitors the discharge/process pressure and is used to generate a differential pressure for cavity one and cavity two.

### Rheometer Control Unit

The Rheometer Control Unit (RCU) contains the control and display components of the rheometer. It is comprised of the PLC, power supplies, and logic control circuitry to drive the Rheometer. The RCU is designed to operate in a non-hazardous location or, with appropriate purge equipment, in a classified area.

### Rheometer

The Rheometer contains the flow producing and flow measurement components of the rheometer. It is comprised of the three gear metering pump, variable speed DC motor, three pressure transducers, two capillaries, temperature sensors and heaters. The rheometer must be close-coupled to the customer polymer melt source.

### Field Wiring

Customer provided field wiring connects the RCU to the Rheometer and the analog and digital signals to the remote process computer. The field wiring is provided by the customer unless otherwise specified.





## EQUIPMENT LIST

Because of the system options available, the customer should refer to his/her purchase order for the particular configuration and accessories. However, the following items are part of the standard DYNISCO Polymer Test rheometer system:

Orifices

### EQUIPMENT REQUIRED – BUT NOT SUPPLIED

Two piece of equipment are required for calibration of the rheometer

1. Dead weight tester that is sufficient range to cover the pressure of interest and
2. A temperature simulator to test the electronics.

Trouble shooting routines will isolate to the module level and should require only a multimeter.

### GENERAL SPECIFICATIONS

#### System Power Requirements

120 VAC 8A OR 230 VAC 5A (refer to field wiring diagram) Current rating is dependent upon an auxiliary heater not exceeding 150 Watts.  
50/60 Hz, 1 phase  
600 W nominal (1000 W during heat up)

#### Rheometer

##### Pressure Transducers

- Cavity 1 250 PSI
- Cavity 2 250 PSI
- Cavity 3 250 PSI
- Combined Error: 0.5% FSO
- Repeatability: 0.1% FSO

Metering Pump: 2 x 0.30 cc/rev

Gear reducer: 43:1 ratio

Heaters: 30 watts each zone

Motor: 1800 RPM ¼ HP Permanent Magnet

Tachometer: Hall Effect pulse output

##### Temperature Probes

- Melt Temperatures: 2 100 $\Omega$  RTD (0.385 $\Omega$ )
- Block Temperatures: 2 100 $\Omega$  RTD (0.385 $\Omega$ )

#### Rheometer Control Unit (RCU)

Analog Output Signals - 4 to 20 mA DC – maximum load 650 $\Omega$

- 5 output channels available
- User selectable from a list that includes  
MFI, pump speed, pump zone temperature, capillary zone temperature, melt



temperature, pressure, and viscosity

- Each output is individually scalable
- Analog Input Channels - 4 to 20 mA DC current, remote sourced
- 2 input channels available
  - User selectable from a list that includes pressure, speed, and temperature
  - Each input is individually scalable

Digital Output Signals - Dry contact relays – 24 VDC 2 A maximum

- System Fault Alarm
- System Warning Alarm
- Local/Remote status
- Pump operating status

Digital Input Signal (24 VDC 10 mA)

- Remote Test On/Off
- Remote Heat On/Off
- Remote Mode (Press/Speed)

Physical Characteristics

See enclosed drawings for actual unit dimensions.

Typical dimensions are show below:

	HEIGHT (in)	WIDTH (in)	DEPTH (in)
RCU	37.2	40.9	9.1
RHEOMETER	22.5	15.25	30.5

### THEORY of OPERATION

Melt viscosity measurements such as Melt Flow Index have long been a primary specification on thermoplastic resins. Because MFI and melt viscosity are related to polymer molecular properties, these numbers give the customer some measure of the physical properties of the product as well as the polymer processability.

The DYNISCO POLYMER TEST rheometer duplicates the test conditions used in laboratory rheometers. These conditions are specified in ASTM D1238. With the laboratory rheometers, pellets are dropped into a test chamber where they are melted, and a weighted plunger on top forces the melt through a capillary orifice. The weight of the extrudate in terms of 'grams/ 10 minutes' is called 'Melt Flow Index (MFI)'. This is a very simple and effective viscosity measurement. However, because of the short capillary L/D, this rheometer measures not only the viscous losses in the capillary but also the visco-elastic losses in the capillary entrance. The measurement in the ASTM plastometer therefore is a function of both the rheometer geometry as well as polymer viscosity. For this reason the ASTM D1238 standard defines both the plastometer as well as the polymer test conditions (Figure I-1).

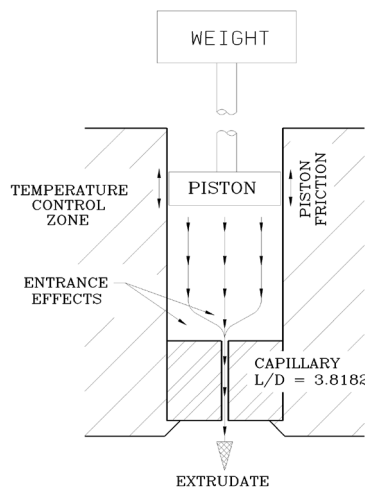

**Figure I-1 LABORATORY RHEOMETER**

Whereas laboratory rheometers are hand loaded with pellets and use weights to create shear conditions, on-line rheometers use the metering pump, orifice and pressure transducer to generate and measure shear conditions. Typical on-line rheometers rely on the process pressure to force the polymer melt into a metering pump and the pump then generates the flow rate and the pressure to extrude the polymer through a precision orifice. Orifice pressure is measured by one or more pressure transducers depending on the type of rheometer. This simple type of on-line rheometer very closely duplicates the internal geometry of the ASTM plastometer.

In the ASTM MFI mode of operation, constant pressure defined by the ASTM method is set by controlling the gear pump flow rate (Figure I-2). Gear pump speed, pump flow rate and flow density then gives MFI directly as a function of pump RPM

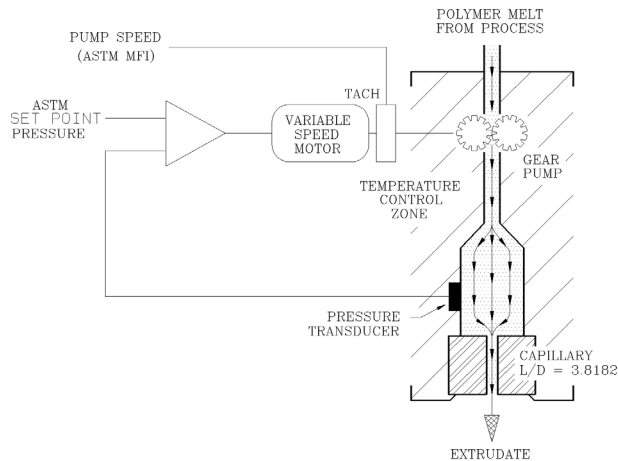

**Figure I-2 ASTM MFI MODE**

In the VISCOSITY mode of operation, constant gear pump speed (SR) is set by controlling the gear pump RPM. The capillary L/D and pump volume can also be changed to set the SR to the necessary range. The pressure is measured above the capillary and used to calculate the SS. The VISCOSITY is calculated from the SS and the SR (Figure I-3).

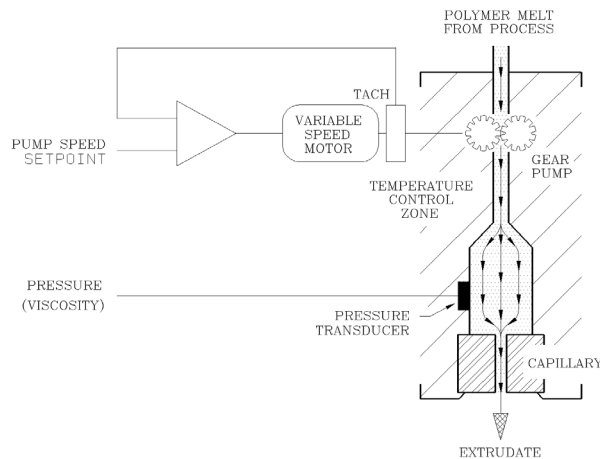

**Figure I-3 VISCOSITY MODE**

The FCRR rheometer makes two viscosity measurements at two widely separated shear rates on a test polymer at the same time. The FCRR returns the polymer sample back to the process.



A single cavity rheometer can perform a multiple shear rate test. However the "practical" shear rate range is limited by the pump speed range and the transducer range. Time is required to allow the polymer to stabilize at the different shear conditions before the measurement data is accurate.

The FCRR performs a dual constant shear rate test. The dual cavity FCRR provides a large difference between the two shear rates. Both measurements are continuous such that the thermal treatment of the polymer in both cavities is identical. The two shear rate tests on an FCRR are independent since each cavity has its own pressure transducer and capillary orifice. A low pressure transducer and short L/D orifice can be installed in one test cavity to set up a low shear rate test condition. A high pressure transducer with a long L/D capillary can be used to set up a high shear rate test in the second test cavity.

(NOTE: Thermal treatment is very important because multiple speed tests often require changes in the overall system temperature profile which can affect the viscosity measurements)

The FCRR returns the sample polymer to the process. A third pressure transducer is located in the passage where the two sample streams merge together and flow back to the process. The pressure measured by the third transducer is subtracted from each of the cavity pressures generating a differential pressure across the capillary. System calculations are based on the differential pressure across the specific capillary.

A block diagram of the FCRR process is shown in Figure I-4.

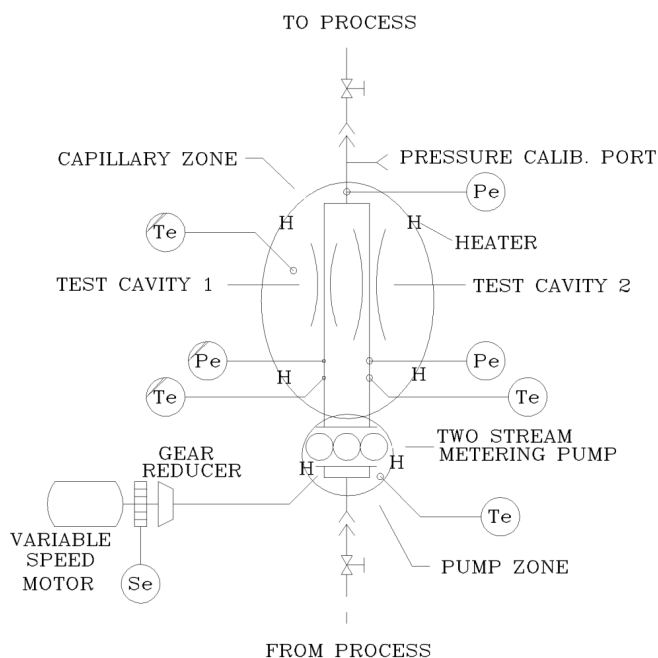

**FIGURE I-4 FCR-R BLOCK DIAGRAM**



## RHEOMETER OPERATION

This portion of the manual provides information on how to operate the rheometer. It is recommended the user review the Operator Display section IV to get familiar with the operation of the display.

### Local Operation

#### External Purge Panel Operation

Refer to the manufacturer's instruction manual for detailed instruction of the proper use of the purge panel. In summary, the air supply must be applied to the purge panel for 30 minutes before the cabinet power can be turned ON.

#### Heat ON

- Apply power to the rheometer control cabinet. Allow the Dynisco startup screen to appear. The 000 MAIN operator screen appears after a few seconds.
- Press the "Heat is OFF" button. The button will change to "Heat is ON" if no fault conditions are preventing the heat from being enabled.
- After 2 to 3 minutes, the indicated temperature should start to climb.
- Change the temperature setpoint in the 110 Setpoint screen.

#### Heat OFF

Press the "Heat is ON" button. The button will change to "Heat is OFF".

#### Motor ON

- Depending on what test is needed, pressure (MFI) or speed (viscosity) control, select that mode on the 110 Setpoints screen.
- Confirm that the Pressure setpoint and Speed setpoint show the correct value. - The heat must be on and at temperature.
- Press the "Motor is OFF" button. The button will change to "Motor is ON".
- Change the speed setpoint in the Setpoint screen. Verify that the pump speed and pressure slowly increases to the setpoint.
- Depending on the required test, speed or pressure, the speed or pressure should settle at the appropriate setpoint. For most MFI tests, the mode of operation is PRESSURE and the pressure set point is 43.2 PSI.
- Verify that the indicated pressure is within the pressure transducer's nominal range (between 10% and 90% of full scale range).

#### Motor OFF

- Press the "Motor is ON" button. The button will change to "Motor is OFF".

### Remote Operation

#### External Purge Panel Operation



- Refer to the manufacture's instruction manual for detailed instruction of the proper use of the purge panel.
- In summary, the air supply must be applied to the purge panel for 30 minutes before the cabinet power can be turned ON.

#### Heat ON

- Apply power to the rheometer control cabinet.
- In screen 253 CFG-Comm, the heat must be installed/enabled for control from a remote source. Enable the remote control in screen 110 Setpoints.
- When the Remote Process Computer energizes the coil, the heaters are enabled.
- After 2 to 3 minutes, the indicated temperature should start to climb.

#### Heat OFF

- The command to disable the heaters may come from the Remote Process computer.
- When the Remote Process Computer de-energizes the coil, the heaters are disabled.

#### Motor ON

- In screen 253 CFG-Comm, the motor must be installed/enabled for control from a remote source.
- Enable the remote control in screen 110 Setpoints.
- When the Remote Process Computer energizes the coil, the motor will be Enabled.

#### Motor OFF

- The command to disable the motor may come from the Remote Process computer.
- When the Remote Process Computer de-energizes the coil, the heaters are disabled

### RECOMMENDED SERVICE SCHEDULE

Visual Leak Inspection – every week.

Gear Reducer – no maintenance is required, the reducer is permanently lubricated and is grease packed.

Pressure Transducer Calibration - every 60 days or after service.

Motor Speed Controller Calibration - every 6 months or after service.



ensure that the equipment is oriented properly (refer to markings on crates to determine which end is up). Open crates and boxes with proper equipment so as not to puncture and damage breakable equipment inside.

After removing the equipment from the crates, carefully inspect each item for shipping damage. Check for dents, scratches, chipped paint, etc., that could have been incurred during transit or while opening the crates. Open the Control Unit and Rheometer and check for broken parts and wires.

**\*\*\*\* IMPORTANT \*\*\*\***

Check the equipment received against the packing list to make sure that all equipment listed has been received. Use established procedures and report immediately any damage or shortages to the carrier.





## INSTALLATION

### Rheometer Control Unit (RCU)

The rheometer is designed to be installed in a process environment. The RCU is housed in a NEMA 4 cabinet and should be located near the Rheometer. Refer to the OUTLINE DIMENSION for mounting information.

#### Considerations for Rheometer Control Unit Location

- Locate the RCU so that the operator interface on the front panel is easily accessible and at eye level for easy operator access.
- Clearance must be provided to open the RCU door for service and trouble shooting.

### Rheometer Installation

The Rheometer is installed at the source of polymer melt. Refer to the OUTLINE DIMENSION (Rheometer) for mounting information.

#### Considerations for Rheometer Location and Installation

1. Free access is available to change capillaries and to calibrate the transducer.
2. Access is available to the extruder adapter shutoff and bleed valves.
3. Extrudate from the capillary and extruder bleed valves can be easily removed.
4. The Rheometer does not interfere with other equipment.

### Interconnecting Field Wiring

Refer to the Field Wiring Diagram for Remote Control Unit to Rheometer wiring and Remote Control Unit to customer equipment wiring. The Field Wiring diagram also gives the required wire size information.

### Grounding

All equipment must be grounded in accordance with applicable electrical codes.

### RCU Purging System

To maintain the RCU safety ratings, the purging system must be installed and set-up according to the manufacturer's instructions. Set the Enclosure Pressure to be in the GOOD range before applying air to the Vortec enclosure cooler.

An alarm or indicator must be connected to the purging system to detect the loss of safe enclosure pressure.

## III. Rheometer Control Unit (RCU) Technical Information

This discussion assumes access to the local operator display. Operation of the local



operator display is discussed in later section of this manual.

The RCU controls the operation of the rheometer. The RCU is able to display data and receive commands from the local display, respond to digital commands from a remote process computer, and provide analog signals to the remote process computer. The RCU can be controlled from a remote IBM-PC compatible computer running optional control software.

The primary functions of the RCU software are: (1) executing feedback control loops ( temperature control and motor control), (2) checking for alarm conditions (high temperature, high pressure, high speed, etc.), and (3) communicating with the operator via the local display, the remote control signals and/or the optional remote PC, and (4) performing the system calculations.

On power up, the RCU enters the “IDLE-NOT READY” process state. The process state and the process status are displayed in the HMI fixed window. The process states are Idle-Not Ready, Warm-up, Idle-Ready, Run, Soak, and Standby. Figure 1 shows the process states.

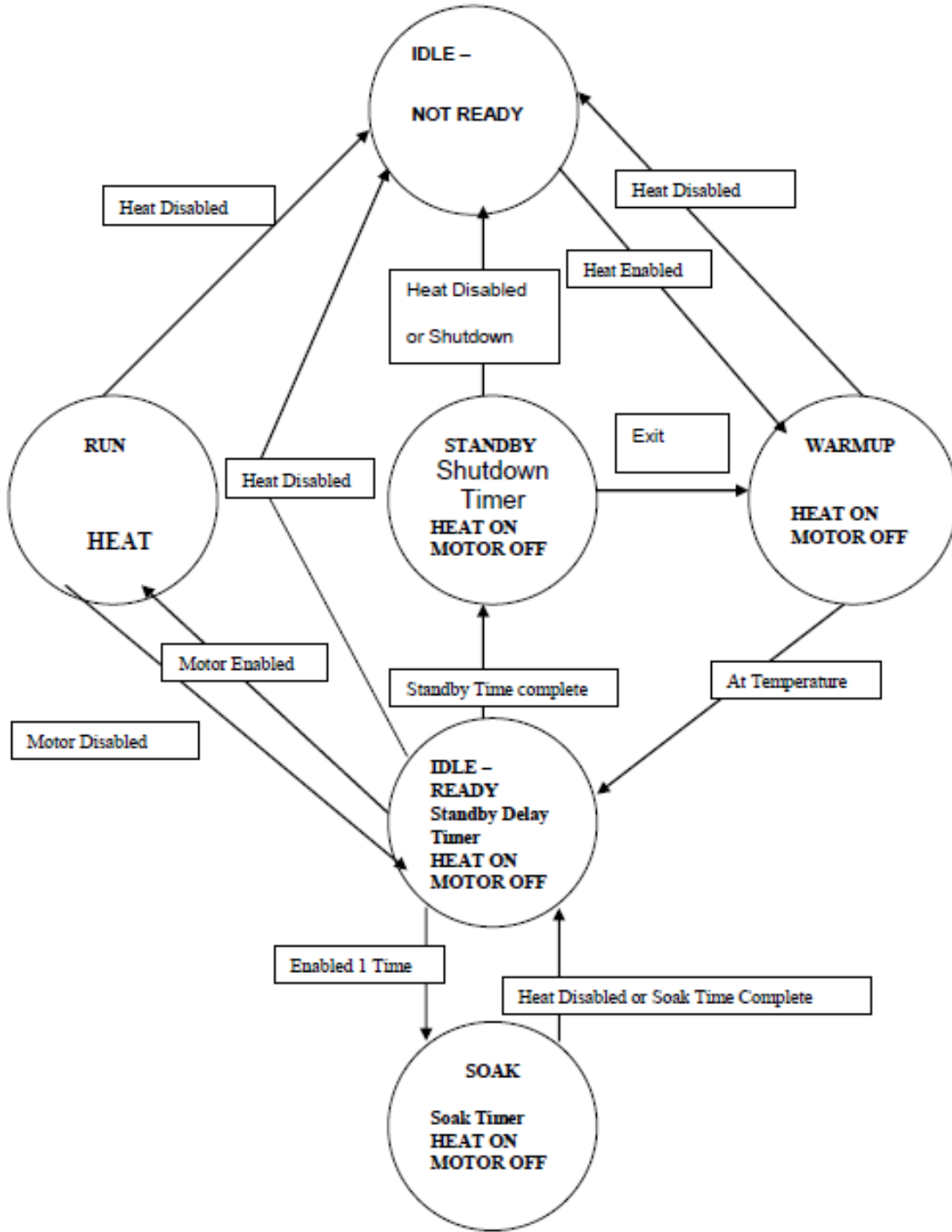

**STATE TRANSITION DIAGRAM**



## SOFTWARE OPERATION

A computer program (software) resides in the CPU module in the RCU. This program controls the operation of the rheometer head.

### Software Timing

In the main loop the following functions are performed at the given intervals:

- Check for alarms -- 500 msec interval
- Update the machine state -- 500 msec interval
- Read 4-20 mA setpoints -- 1 second interval
- Read remote discrete inputs -- 1 second interval
- Write to HMI -- 1 second interval
- Write 4-20 mA outputs -- 1 second interval
- Write RS-232 outputs --- 1 second interval
- Acknowledge alarms -- 1 second interval
- Perform rheometer calculations -- 2 second interval
- Update HMI faults/warnings -- 2 second interval

Every 250 milliseconds, a CYCLIC INTERRUPT routine is executed. The cyclic interrupt controls the timing for the following functions:

- All pressures are sampled every 250 milliseconds and converted to the desired engineering units. The sampled values are averaged over a 5 second window to produce the pressure value. When the motor is running, the motor PID loop controls the motor depending on the mode selected (PRESSURE or SPEED).
- The metering pump speed is sampled every 250 milliseconds and converted to engineering units (RPM). The sampled values are averaged over a 1 second window to produce the speed value. When the motor is running, the motor PID loop controls the motor depending on the mode selected (PRESSURE or SPEED).
- The temperatures are sampled every 500 milliseconds and converted to engineering units (degrees Celsius). The sampled values are averaged over a 5 second window to produce the temperature value. When the heat is on, all temperature PID loops are controlling the temperatures.

Every minute an interrupt routine is executed. This routine handles the soak/standby/shutdown/purge timers along with the machine hour statistics. The accuracy of the timers is +/- 1 minute.

Test parameters and transducer calibrations values are stored in the battery-backed memory and will be “remembered” if the rheometer is powered off. If a PROGRAM ERROR occurs (any error that could “lock up” the CPU), the motor and heaters will be turned off.





## Alarm/Fault Logic

One of the major functions of the RCU control system is to check for various alarms detailed below. Some of these alarms are "warnings". Warnings appear in yellow in the process status on the HMI. Warnings also deactivate the warning relay (contacts will open). Warnings exist for information only. In these cases, the RCU takes no further action beyond the indication. Faults are conditions that can result from a hardware failure and could result in equipment damage. Faults appear in red in the process status on the HMI. Faults deactivate the fault relay (contacts will open). Each alarm is described below along with the action the RCU will take.

### WARNINGS

#### Temperature Low

- CAUSE: The heat is enabled, the motor is disabled, and the temperature is below the low limit as set in screen 257 CFG – Limits

#### Temperature High

- CAUSE: The heat is enabled and the temperature is above the high limit as set in screen 257 CFG – Limits

#### Pressure Low

- CAUSE: Pressure is below the low limit as set in screen 257 CFG – Limits
- CAUSE: Pressure is below 10% of the full scale transducer range

#### Pressure High

- CAUSE: Pressure is above the high limit as set in screen 257 CFG - Limits

#### Speed Low

- CAUSE: In speed mode, the motor is enabled and the speed is below the low limit as set in screen 257 CFG – Limits
- CAUSE: Speed is less than the minimal allowable speed (1 RPM)

#### Speed High

- CAUSE: In speed mode, the motor is enabled and the speed is above the high limit as set in screen 257 CFG – Limits
- CAUSE: Speed is 1% over the maximum allowable speed (40 RPM)

#### MFI/MV/RV/IV Low

- CAUSE: The material property selected in screen 132 Setup-Warning is below the low limit selected.

#### MFI/MV/RV/IV High

- CAUSE: The material property selected in screen 132 Setup-Warning is above the high limit selected.



## FAULTS

### Temperature Low

- CAUSE: The heat is enabled and the motor is enabled (RUN state) and the temperature is below the low limit as set in screen 257 CFG – Limits
- ACTION: Shuts off the motor

### Temperature High

- CAUSE: The temperature exceeds the maximum temperature as set in screen 257 CFG – Limits.
- ACTION: Shuts off the motor - Shuts off the heater

### Pressure Low

- CAUSE: The scaled pressure transducer reading is 5% below the transducer's zero output.
- ACTION: Shuts off the motor

### Pressure High

- CAUSE: The scaled pressure transducer reading exceeds the full scale range of the transducer by 5%.
- ACTION: Shuts off the motor

### Speed Low

- CAUSE: Speed is less than the minimal allowable speed (1 RPM) for 1 minute
- ACTION: Shuts off the motor

### Speed High

- CAUSE: The speed exceeds the maximum motor speed by 1% (40.4 RPM) for 1 minute
- ACTION: Shuts off the motor

### Motor Fault

- CAUSE: A motor fault has occurred
- ACTION: Shuts off the motor

### Emergency Stop

- CAUSE: The emergency stop input has been deactivated.
- ACTION: Shuts off the motor – Shuts off the heater

### Calib Error

- CAUSE: Occurs when attempting to calibrate the pressure transducer under the following conditions
  1. Heat is OFF.
  2. Rheometer is "Below Temp".
  3. Motor is running.
- ACTION: unable to start the Motor

### Temperature Fault

- CAUSE: no sensor or faulty sensor connected to the PLC module



- ACTION: Shuts off the motor - Shuts off the heater

#### Pressure Fault

- CAUSE: no sensor or faulty sensor connected to the PLC module
- ACTION: Shuts off the motor

#### Speed Fault

- CAUSE: no sensor or faulty sensor connected to the PLC module
- ACTION: Shuts off the motor

### CPU OK Indicator

To indicate the PLC software is executing, PLC module 9 the last LED (second group channel 7) will flash. This is the CPU is alive indicator. To indicate communication to the HMI, the LED above the CPU Alive indicator will flash. This is the HMI is alive indicator.

### CPU Memory Reset

It may be necessary to reset the CPU's memory under the following conditions,

1. Installation of new software.
2. Resetting all system values to the factory default.
3. The CPU SF LED is illuminated.
4. Erratic operation.

The application software is stored on the removable flash EPROM in the CPU module. All system variables are stored in the CPU RAM. To reset the CPU memory,

1. Place the CPU RUN-STOP-MRES switch to OFF. The CPU front panel LED's should change from RUN to STOP.
2. Hold the RUN-STOP-MRES switch in the MRES position for 3 seconds. The STOP LED should flash.
3. Release the RUN-STOP-MRES switch, the switch should return to the STOP position.
4. Wait 2 seconds and again hold the RUN-STOP-MRES switch in the MRES position. The STOP LED should flash and then stay ON.
5. If the CPU SF LED is ON, repeat 2 through 5.
6. Place the RUN-STOP-MRES switch to the RUN position, the CPU pilot LED on the PLC Digital Output module should flash every 1/2 second.



## HARDWARE DESCRIPTION

Major RCU components include AC power devices, DC power supplies, MSC (Motor Speed Controller), the PLC modules including analog and digital signal conditioning modules.

### AC Power Protection

Main power is supplied through Main Power switch S-1. Breaker BR1 provides protection for the RCU cabinet. The motor speed controller (MSC) contains an input and output fuse for protection. Refer to the proper assembly drawings for details.

### AC Power Relays

There are two high current relays to switch line power to the heater circuits and the MSC (ENABLE relays). In the heat control circuit, SSR's (solid state relays) send the line AC power to each individual heater.

### Power Supplies

There are two DC power supplies in the RCU. A 24 VDC power supply provides power for the analog and digital modules (external power), the heater control relays, power enable relays and the motor over-temperature switch. A 10 VDC power supply provides power for the pressure transducer. (Intrinsically safe units replace the 10 VDC power supply with a 17 VDC power supply). The PLC has an internal 24 VDC power supply, which also provides power for the local display panel. The frequency-to-voltage converter module supplies the power for the tachometer.

### CPU Module

The CPU module is the "brain" of the RCU. Major functions include supervising the rheometer heaters and drive motor, communicating data to the optional PC, and providing the operator display feature.





## Analog Signal Conditioning

Low-level analog signals generated by RTD's pressure transducers, and tachometer voltages are not compatible with the digital circuits that comprise the CPU. These analog signals must be converted into a form suitable for the CPU.

Analog Input Modules.

The PLC uses two analog input modules. The first input module is setup to read the RTD sensors inputs. The second input module is setup to read the pressure transducer millivolts, the tachometer voltage, and any optional remote analog input signals.

Shown below is an example of how the remote analog inputs are converted into set points. The remote analog inputs are selected on screen 255 CFG mA in. The analog inputs are calibrated and scaled on screen 241Ana In Cal 2.

$$\left( \frac{(\text{input}_{\text{mADC}} - 4_{\text{mADC}})}{16_{\text{mADC}}} \right) \times \text{RANGE} + 4_{\text{mA\_value}} = \text{SP}_{\text{eng}}$$

RANGE = 20\_mA\_value – 4\_mA\_value  
(set the 20 mA and 4 mA limits in screen 241 Ana In Cal 2.)

SP = setpointengineering units.

With the 4-20 mA input scaled to 0-48 RPM, a 5.33 mA input produces a speed setpoint of 4 RPM.

$$\left( \frac{(5.33_{\text{mADC}} - 4_{\text{mADC}})}{16_{\text{mADC}}} \right) \times (48 - 0)_{\text{RPM}} + (0)_{\text{RPM}} = 4.0_{\text{RPM}}$$



## Analog Output Modules

The PLC uses two analog output modules. This module provides a 0 to 10 VDC control signal to the motor speed controller and the 4 to 20 mA DC output signals for the remote process computer.

Shown below is an example of how values are converted into a 4 to 20 mA DC output signal. The remote analog outputs are selected on screen 256 CFG mA out. The analog outputs are calibrated and scaled on screens 242 Ana Out Cal 1, 243 Ana Out Cal 2, and 244 Ana Out Cal 3.

$$\left( \frac{PV_{\text{eng}} - PV_{\text{min}}}{PVFS_{\text{eng}}} \right) \times 16_{\text{mA DC}} + 4_{\text{mA DC}} = \text{Output}_{\text{mA DC}}$$

PV = Process variable engineering units

PVmin = min mA value

PVFS = Process variable full scale engineering units = max mA value – min mA value

Max and Min mA values are set in screens 242-244

With a temperature of 40 C, and a min scaled value of 0.0 C and a max scaled value of 80.0 C

$$\left( \frac{40.0\text{C} - 0.0\text{C}}{80.0\text{C} - 0.0\text{C}} \right) \times 16_{\text{mA DC}} + 4_{\text{mA DC}} = 12.00_{\text{mA DC}}$$

## Digital Signal Conditioning

DIGITAL INPUT MODULE

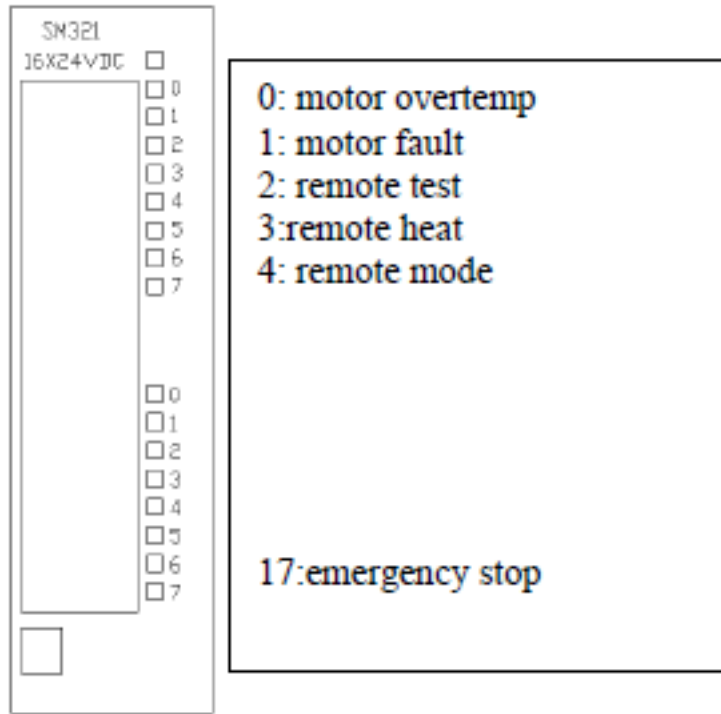

FIGURE III-2 - Digital Input Module

### Digital Input Module

All digital input signals to the PLC are 0 (zero) or 24 VDC. The digital input signals are generated internally (safety voltage, etc.) or from an external source (Remote Test Start/Stop, etc.). The internal digital input signals are connected directly to the PLC digital input module. The remote digital input signals are connected to a PLC RELAY. The PLC RELAYS are used to isolate each PLC digital channel. The PLC RELAY is discussed elsewhere in this section. Each digital input channel has an LED to indicate when the input signal is present.

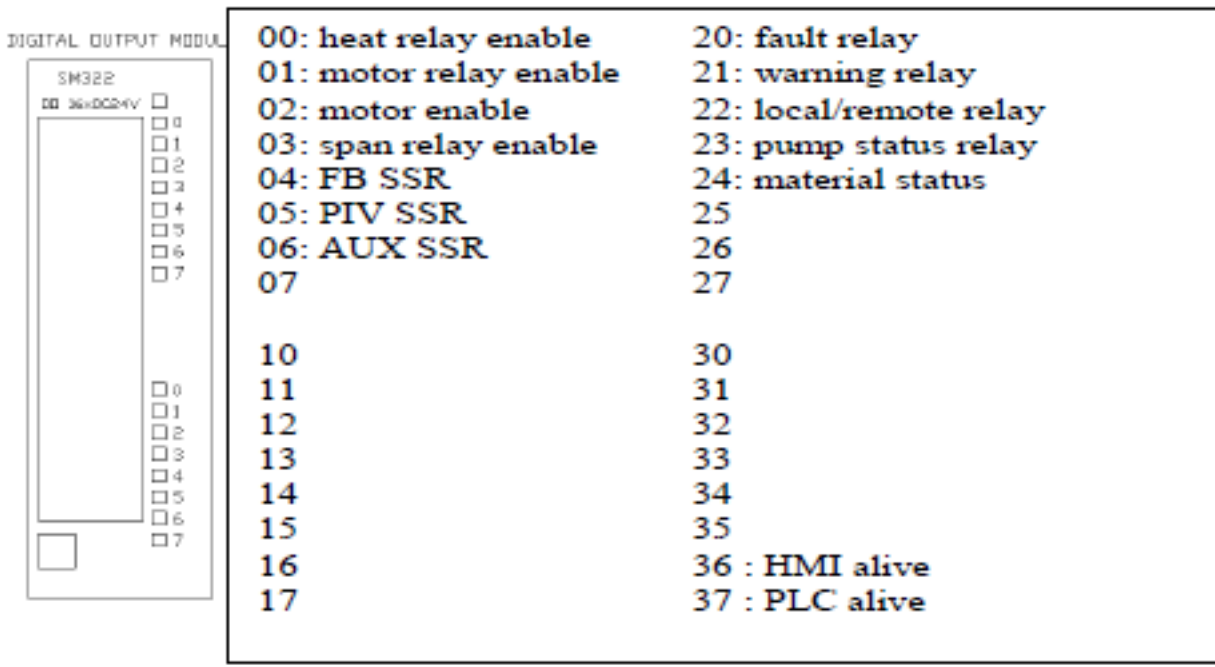
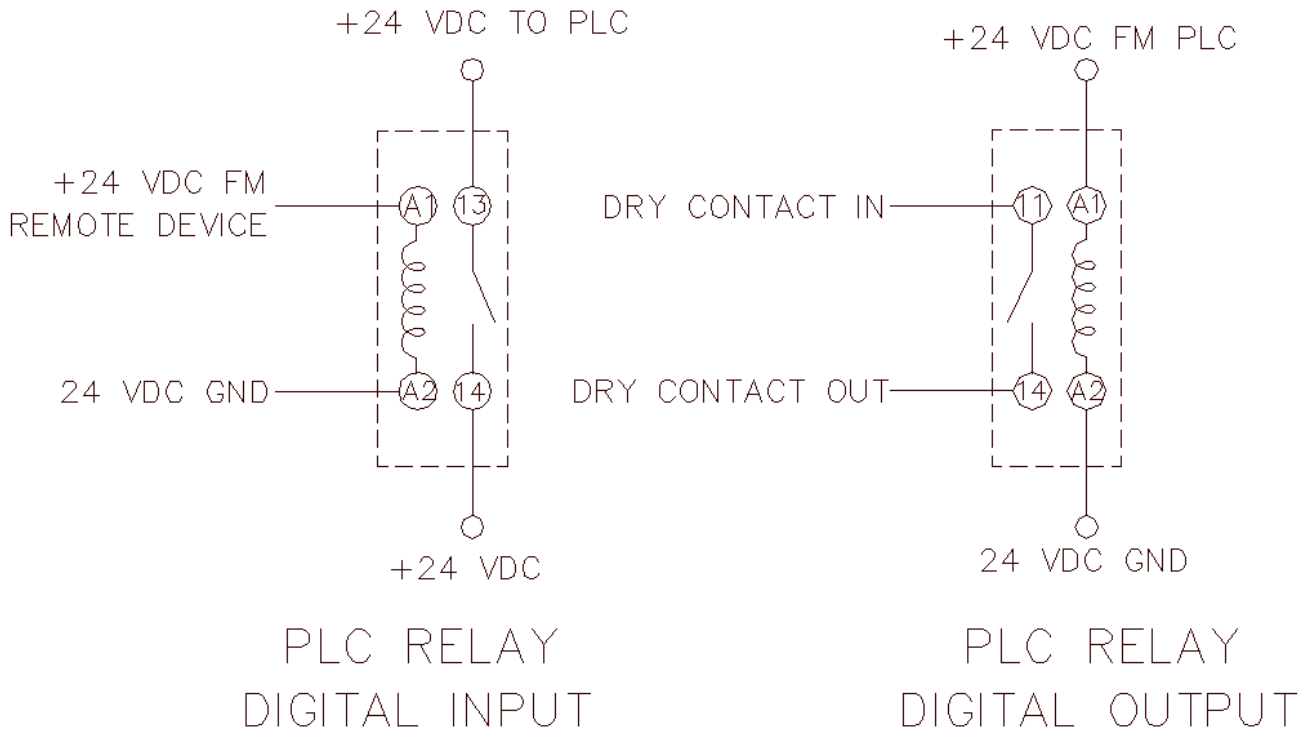

FIGURE III-3 - Digital Output Module

### Digital Output Module

All digital output signals from the PLC are 0 (zero) or 24 VDC. The digital output signals are used internally to drive various relays (Heat Enable, Temperature Control, etc.) or provide a dry contact for an external device. The internal digital output signals are connected directly to a control relay. The digital input signals used for an external device are connected to a PLC RELAY. The PLC RELAYS are used to isolate each PLC digital channel. The PLC RELAY is discussed elsewhere in this section. Each digital output channel has an LED to indicate when the output signal is present.



**FIGURE III-4 - PLC RELAYS**

The purpose of the PLC-RELAYS is to isolate the PLC from external devices, both input and output. The RCU uses a single pole single throw normally open PLC-RELAY. 24 VDC input coils are used unless otherwise specified.



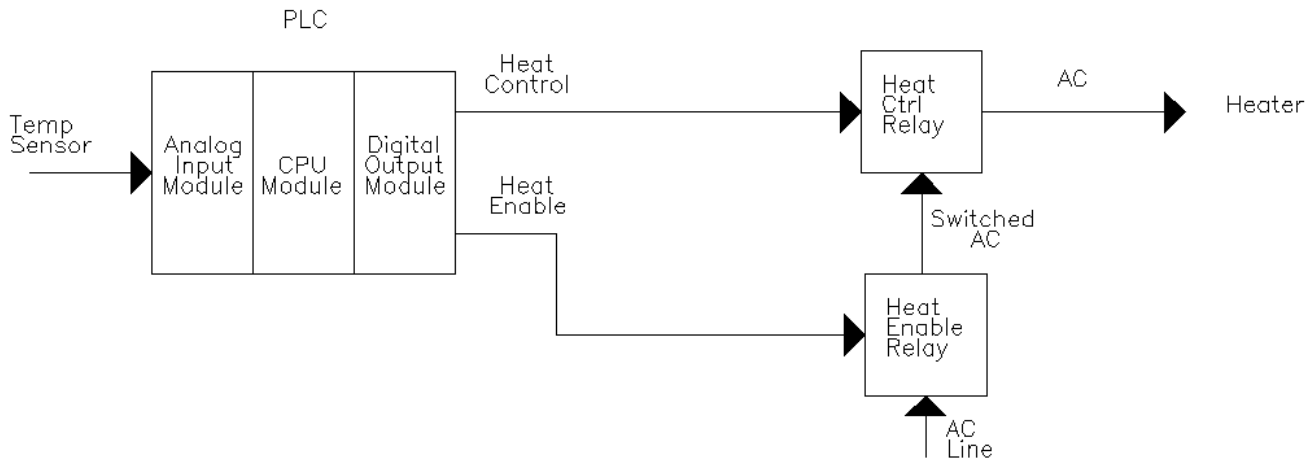

**FIGURE III-5 - Simplified Temperature Indication and Control**

### Temperature Indication

Each individual temperature is read by a grade "A" 100Ω RTD. The low-level temperature signal is connected to the rheometer control unit via the field wiring. The low-level signal is fed to the PLC ANALOG INPUT MODULE where it is converted into a digital code. This digital code is used by the PLC's firmware to calculate the indicated temperature in engineering units.

### Temperature Control

The indicated temperature is compared to the temperature setpoint in the temperature PID control loop. The output of the temperature control loop is the value necessary to maintain the temperature setpoint. This output value is 0 to 100%. The output signal is known as a TPO (Time Proportional Output) signal. Figure III-6 (top) shows an example of a 50% duty cycle heater control signal for 2 one second cycles.

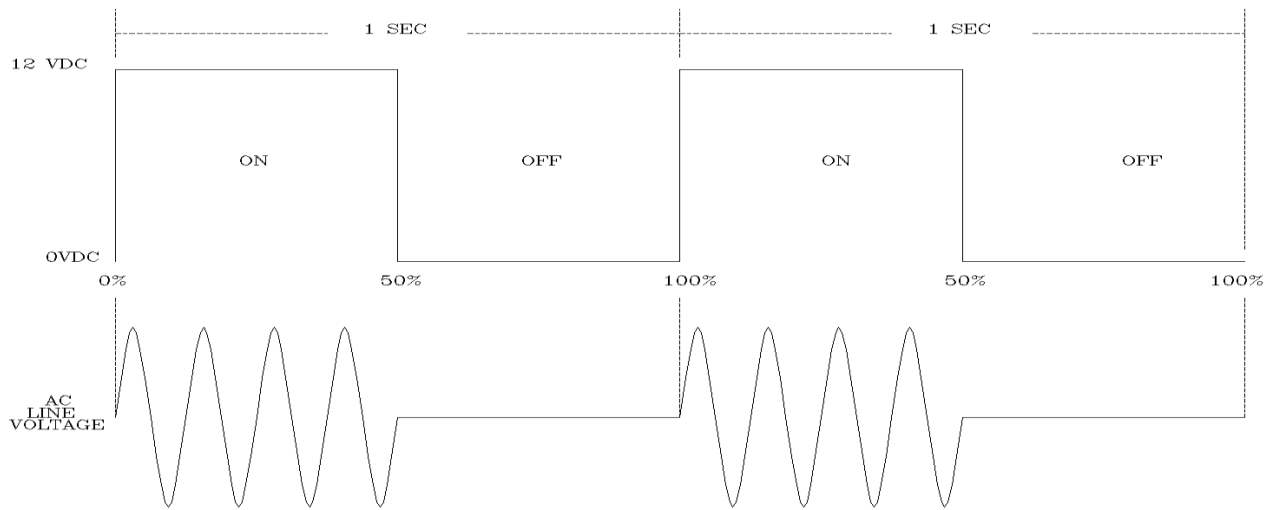

**FIGURE III-6 - Time Proportional Control Signal**

The TPO heater control signal is fed via the cabinet wiring to the HEAT CONTROL PLC Relay and then to the SSR (solid state relay). When the LED on the PLC DIGITAL OUTPUT MODULE for that TPO channel is ON, the DC TPO control signal is fed to the heat control SSR. The CPU also switches the AC power to the HEAT ENABLE relay. When the operator turns the HEAT ON, the PLC enables the HEAT ENABLE relay. When the LED on the PLC DIGITAL OUTPUT MODULE for that channel is ON the HEAT ENABLE relay feeds the line AC voltage to each HEATER CONTROL SSR. When the heat control SSR relay is on, it acts like a switch and allows the line AC voltage to be delivered to the heater (based on the control signals duty cycle). Figure III-6 (bottom) shows a 50% duty cycle DC control signal and the associated heater AC signal.



### Motor Indication and Control

#### Pressure Indication

The capillary pressure is read by a pressure transducer (unbonded strain gauge wheat stone bridge). The low-level pressure signal is connected to the RCU via the field wiring. The low-level signal is fed to the PLC ANALOG INPUT MODLE where it is converted into a digital code. The digital code and the pressure calibration data are used by the CPU's firmware to calculate the pressure in engineering units.

#### Speed Indication

The motor/metering pump speed is a 0 to 2400 Hz signal generated by the tachometer. The frequency signal is fed to a frequency to voltage converter. The output of the frequency to voltage converter is a 0 to 10 VDC signal. The low-level signal is fed to the PLC ANALOG INPUT MODULE where it is converted into a digital code. The digital code and the speed calibration data are used by the CPU's firmware to calculate the pump speed in engineering units.

#### Motor Control

The meter pump speed or capillary pressure (depending on the mode selected) is compared to the motor setpoint in the CPU. The output of the motor control loop is the value necessary to maintain the motor setpoint. This output value is scale to the range of 0 to 100 %. This signal is fed to the PLC ANALOG OUTPUT MODULE where it is converted into a 0 to 10 VDC motor control signal. Min and Max pots are adjustable on the MSC. The CPU also switches the AC power to the MOTOR ENABLE relay. When the operator turns the MOTOR ON, the MOTOR ENABLE Relay is energized. When the LED on the PLC DIGITAL OUTPUT MODULE for that channel is ON, the MOTOR ENABLE relay feeds the line AC voltage to the motor speed controller.

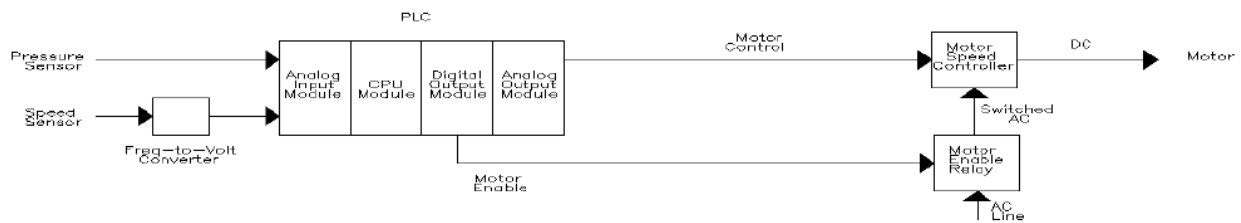

FIGURE III-7 - Simplified Motor Indication and Control

### Hardware Safety Interlocks

Voltage from the 24 VDC power supply is sent to the rheometer through the field wiring. This voltage is connected to the normally closed (NC) contacts of a thermostat located inside the Rheometer motor and returned to the RCU. This signal is sent to the PLC Digital input module. When the motor internal temperature exceeds 100°C, the 24 VDC path is broken, indicating an over temperature condition. The PLC then disables the motor and heaters until the alarm condition is cleared.

Optional External Skin Temperature monitors are available that measure the heater temperature. In event of a heater thermal overrun condition, the 24V supply voltage is removed from the PLC Digital output module which in turn disables the heater zones. The PLC also monitors this alarm signal and indicates a skin temp alarm on the HMI screen. Heat cannot be restored until the alarm condition is corrected.

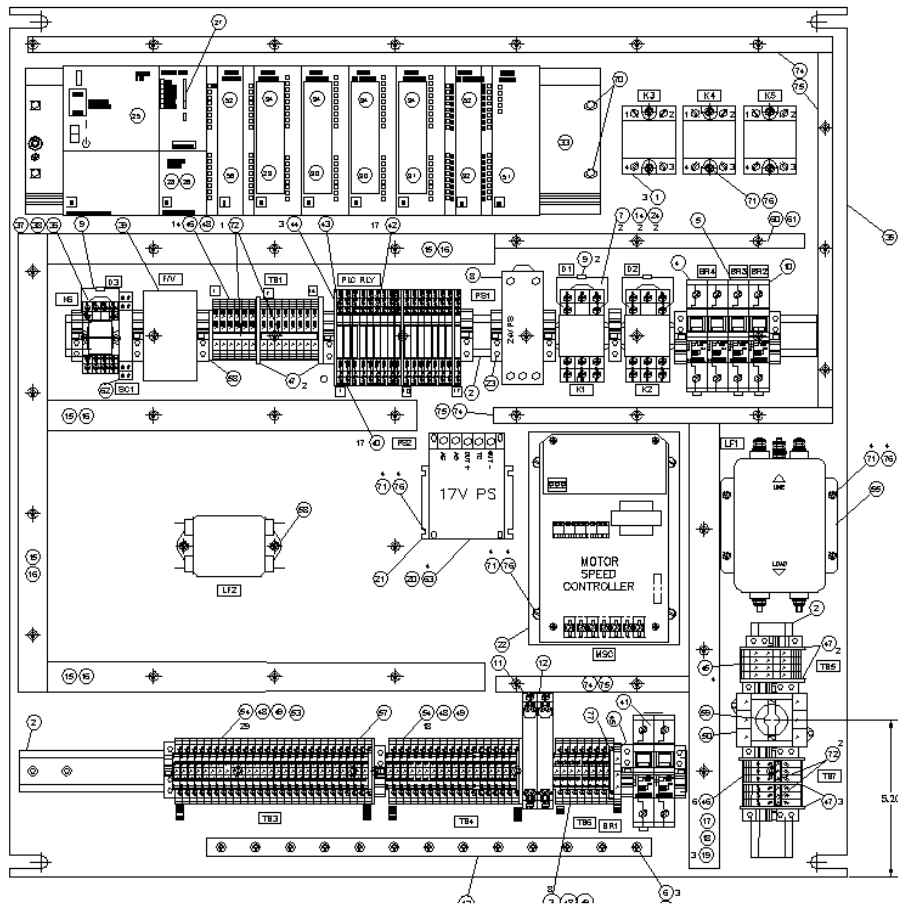

Figure III-8 - RCU PARTS LOCATION



PARTS LIST			
ITEM NO.	PART NO.	QTY. REQ'D	DESCRIPTION
01	9966-3991	3	RELAY 10 A 120/240V SOLIDSTATE
02	9966-3222-01	1	MOUNTING RAIL
03	9966-5220	39	TERMINAL BLOCK
04	9071-858-5	1	CIRCUIT BREAKER, 5A, DP
05	9071-701	1	CIRCUIT BREAKER, SINGLE POLE 0.5 AMP
06	9966-5798	3	SPACER 50 X .625
07	9967-1397	2	SPRING RELAY
08	9967-4670	1	POWER SUPPLY 30W 24VDC
09	9967-3294	3	DIODE, 1N4007 RECTIFIER 1A1000V
10	9071-702	1	CIRCUIT BREAKER, SINGLE POLE 1 AMP
11	9967-3725	1	I-SAF BARRIER
12	9967-3726	1	I-SAF BARRIER
13	9967-3807	1	SHIELD RAIL
14	9967-4614	2	RELAY
15	9967-3827	6	RACEWAY, WHITE 1
16	9967-3828	6	RACEWAY COVER, WHITE 1
17	9967-3829	2	RACEWAY, GREY
18	9967-3830	2	RACEWAY COVER, GREY
19	9967-3891	3	VARIABLE RESISTOR
20	9967-3721-01	1	POWER SUPPLY, 17VDC, 115VAC
21	9967-4753	1	BRACKET, POWER SUPPLY MOUNT
22	9966-9945-01	1	MOTOR SPEED CONTROL ASSY - 115 VAC with 90V DC motor
23	9966-5208	17	CLAMP, END
24	9966-8376	2	SOCKET RELAY
25	9967-4586	1	PS307 115/230 VAC P/S 24VDC
26	9967-4657	1	CPU, SIEMENS
27	9967-4658	1	MICRO MEMORY CARD, SIEMENS
28	9967-4656	1	PROFIBUS CABLE FOR HMI - 1M
29	9967-4590	1	ANALOG INPUT
30	9967-4591	2	ANALOG OUTPUT
31	9967-4592	1	DIGITAL INPUT
32	9071-485	1	DIGITAL OUTPUT, 32 PIN
33	9967-4594	1	MOUNTING RAIL
34	9967-4595	4	TERMINAL BLOCK, 20 PIN
35	9967-4752	1	PLATE, MOUNTING, RCU/PLC
36	9966-9830	1	SPRING CLIP, RELAY
37	9967-4613	1	RELAY
38	9966-9832	1	SOCKET, RELAY
39	9967-4615	1	FREQ TO VOLT CONVERTER
40	9967-4617	8	PLC RELAY
41	9071-858-8	1	CIRCUIT BREAKER, 8A, DP
42	9967-4620	1	PLUG-IN BRIDGE, BLUE
43	9967-4621	1	PLUG-IN BRIDGE, RED
44	9967-4622	3	SEPARATOR PLATES
45	FV219422	2	TERMINAL BLOCK, GND, 3 CONTACTS
46	FV219423	19	TERMINAL BLOCK, 3 CONTACTS
47	FV219424	4	TERMINAL BLOCK COVER
48	9966-5209	1	MARKER SYSTEM SBS6: 1-20
49	9966-5210	1	MARKER SYSTEM SBS6: 21-40
50	9967-3797	1	DISCONNECT SWITCH, 3 POLE

51	9071-552	1	MODULE, RS232
52	9071-486	2	TERMINAL BLOCK, 40 PIN
54	9071-488	18	TERMINAL BLOCK
55	9967-3768	1	FILTER, POWER INPUT
56	9967-4632	1	MODULE, RTD INPUT SIEMENS
57	9071-487	1	DIAM RAIL END COVER
58	9967-3677	2	SEPARATOR
59	9967-4266	1	SWITCH EXTENSION SHAFT
60	9967-4724	2	RACEWAY, WHITE 1/2
61	9967-4725	2	RACEWAY COVER, WHITE 1/2
63	HW50012	4	SCREW, 4-40 X 1/4 SHCS
64	508736	3	SCREW, 1/4-20 X 1-1/4 HCS
65	AW010	3	WASHER, 1/4 EXTERNAL TOOTH
66	W0118	3 FT	WRAP, SPIRAL 1/2 OD CLEAR
68	AX036	2	TERMINAL RING SOLDERLESS 1/4"
69	FV401007	80	SCREW, 8-32 X 3/8 BHMS SS
70	7024-0688	10	SCREW, 10-32 X 3/8 PH PHIL
71	9963-0819	12	SCREW, 6-32 X 3/8 PH PHIL
72	1351020	2	DIAM RAIL JUMPER, 10 POSITION, WITH SCREWS
74	9071-554	5	RACEWAY, 1/2" GREY
75	9071-555	5	RACEWAY COVER, 1/2" GREY
76	581340	10	WASHER, #6 LOCK
77	9966-5223	2	TERMINAL BLOCK COVER
78	T0399	AR	TERMINAL, SPADE INSULATED 22-18 AWG
79	T0400	AR	TERMINAL, SPADE INSULATED 22-16 AWG
80	T0401	AR	TERMINAL, SPADE INSULATED 12-10 AWG
81	F0248	AR	FERRULE, 18 GA RED SINGLE
82	F0247	AR	FERRULE, 16 GA BLK DUAL
83	EN0532	AR	FERRULE, 20 GA WHI SINGLE
84	EN0535	AR	FERRULE, 18 GA RED DUAL
85	AW050	AR	WIRE, 16 GA BLK 600V CSA
86	AW090	AR	WIRE, 18 GA WHI/LT BLU 300V CSA
87	W5047	AR	WIRE, 16 GA GRN/YEL 600V CSA
88	FV220026	AR	WIRE, 18 GA BLU 300V CSA
89	FV220032	AR	WIRE, 16 GA RED 600V CSA

Figure III-9 - RCU PARTS LIST

PLC MODULE LIST	
MODULE	TYPE
1	Power Supply





2	CPU
3	Not used (reserved for expansion rack)
4	Analog Input (RTD)
5	Analog Input (Voltage/Current)
6	Analog Output
7	Analog Output
8	Digital Input
9	Digital Output
10	RS-232 Serial ASCII data string output

DIGITAL INPUTS Module 8		DIGITAL OUTPUTS Module 9	
Term#	Function	Term#	Function
2	Not Used	2	Heat Relay Enable
3	Motor Fault	3	Motor Drive Enable
4	Remote Test/Start	4	Not Used
5	Remote Heat	5	Xd Span
6	Remote Mode	6	Flow Block heater SSR
7	Load Recipe 1	7	PIV heater SSR
8	Load Recipe 2	8	AUX heater SSR
9	Load Recipe 3	9-15,20,21	Not Used
10-11	Not used	16-19	Recipes 1-4 Active
12	BEBCO (optional)	22	Fault Relay
13	Skin temp (optional)	23	Warning Relay
14	Load Recipe 4	24	Local/remote Relay
15-18	Not used	25	Motor/pump is on Relay
19	Emergency stop	26	Material Status Relay
		27-29	Not used
		30	HMI is alive indicator
		31	CPU is alive Indicator

PLC RELAY LIST		
Module	Function	I/O
1	Fault	Output
2	Warning	Output
3	Local/remote status	Output
4	Pump run status	Output
5	Material status	Output
6	Recipe 1 Active	Output
7	Recipe 2 Active	Output
8	Recipe 3 Active	Output
9	Recipe 4 Active	Output
10	Remote motor start	Input
11	Remote heat enable	Input
12	Remote mode (pressure/speed)	Input
13	Load Recipe 1	Input
14	Load Recipe 2	Input
15	Load Recipe 3	Input
16	Load Recipe 4	Input



Refer to field wiring drawing for connection to the PLC relays.

#### IV. Local Operator Display

The DYNISCO Polymer Test RCU is equipped with an operator interface device mounted in the RCU cabinet or in a remote location determined by the customer. The operator interface is used to view and modify the system variables. This includes current measured values, test setpoints, trend screens, and alarm condition indicators. The display is a color touch screen

#### ENVIRONMENTAL CONSIDERATIONS

The display will operate at temperatures between 32°F and 122°F (0 to 50C). Humidity may be between 10% and 90%. The unit is rated for NEMA-4 (water-tight) and NEMA-12 (dust-tight) provided the mounting gasket is intact.

#### SECURITY

Three levels of security are provided for operating the display. Refer to the screen structure to determine the security level required for each screen.

USER NAME	Password	Authority
Setup	330	Ability to change material specific parameters
FCR	FCR	Ability to change material specific parameters
Maintenance	Alpha	Access to instrument configuration and test functions
Service	Alpha	Access to instrument configuration and test functions
MAINT	ALPHA	Access to instrument configuration and test functions
Factory	call factory	Access to advanced instrument configuration

**Maintenance privileges allow access to the diagnostic screens. Extreme care must be used while accessing the diagnostics since the instrument can be damaged by untrained personnel!**

#### HMI SCREEN DISPLAY OVERVIEW

At the top of most of the screens is an area called the “Fixed Window”. Items in the fixed window are labeled below. The display screens are shown on the following pages.

- PLC ALIVE Indicator
- HEAT ON/OFF Button/Indicator
- Motor ON/OFF Button/Indicator (when available)
- Process Status Warnings/Faults
- Process State
- Screen Name and dropdown list for screen navigation
- Help Button
- Minutes Timer (when available)
- Machine Model FCR/CMR/ViscoSensor
- Alarm Acknowledge Button

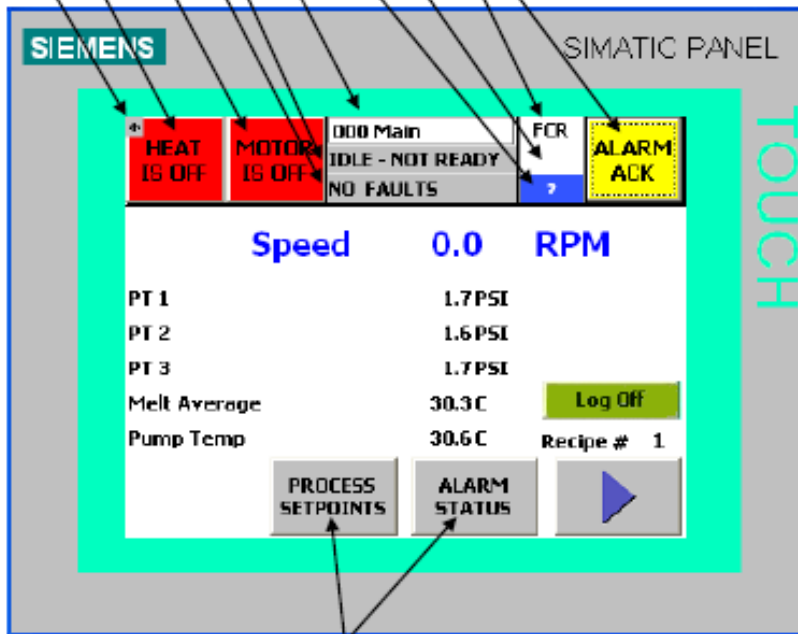

Buttons to navigate to the named screen

- Previous screen
- Next screen
- Go to screen 000 Main
- Press to enter data values
- Acknowledge (clear) alarm messages
- Help for the current screen



Press to enable the heat



Press to disable the heat



Press to enable the motor



Press to disable the motor

Screens on the display are divided into groups. A brief description of each group is followed by a detailed section.

#### Startup screen

MAIN screen and MENU screens (000,100,200,300)

- The items displayed on the MAIN screen are configured in the Operator Setup screen. The right arrow key opens the MENU screens that are used to select and display items of interest.

#### Process Setpoints (110)

- This screen is used to set the temperature, pressure, and speed control setpoints.

#### Equation Constants (120-123)

- These screens are used to set the capillary diameter, length to diameter ratio, pump volume, correlation factor, flow index, activation energy, flow density, reference temperature, reference pressure, the intrinsic viscosity coefficient, and the intrinsic viscosity exponent.

#### Operator Setup (130-138)

These screens are used to

- Select the items to be displayed on the MAIN screen,
- Configure the soak mode,
- Configure the standby mode,
- Configure the shutdown mode,
- Configure the warning for material of range,
- Configure the sample/purge mode,
- Set the ASCII communication interval and the information to be communicated, and
- Set the date and time

#### Recipes (140)

- Job setup recipes are used to store the configuration of the instrument such that it can be recalled at a later date. This aids in change over from one material to another.

#### Process Status (150)

- This screen is used to observe the process temperatures, pressures, and speed.





#### Equation Results (160)

- This screen is used to observe the melt flow index, shear rate, shear stress, melt viscosity, relative viscosity, and intrinsic viscosity.

#### Alarm Status (170-172)

- These screens show the status of the temperature RTDs, the pressure transducer, the motor, and the emergency stop.

#### Trending Graphs (180-186,190-196)

- These screens graph the selected value over a 10/60 minute time window. Trend screens are provided for temperature, pressure, speed, melt flow index, shear rate, melt viscosity, relative viscosity, and intrinsic viscosity.

#### Temperature Calibration (210-211)

- Calibrate temperature measurements by entering offset values for the appropriate RTD temperature measurement.

#### Pressure Calibration (220-222, 230-232)

- These screens provide a method to calibrate the pressure transducers. Calibration options include default, auto cal, and manual.

#### Analog I/O Calibration (240-245)

These screens allow for

- Calibration and scaling of the motor speed input from the tachometer,
- Calibration and scaling of the 4-20 mA input setpoints,
- Calibration and scaling of the motor speed output from the PLC to the motor speed controller,
- Calibration and scaling of the 4-20 mA output values.

#### Machine Configuration (250 - 259,25A – 25C)

These screens are used for configuring the instrument. The following items get configured:

- Instrument model type
- Units for length, temperature, and pressure
- RTD and pressure transducer configuration
- Installing options
- Selecting the 4-20 input and output parameters
- Setting the over temperature
- Setting the temperature, pressure, and speed warning limits
- Setting the PID control constants

#### Manual Purge (320)

- This screen is used to purge the system of material. The system will operate at the set speed for a given amount of time. After the time expires, the motor/pump will stop and the heat will be disabled.





#### Error Log (270-272)

- The last 25 faults are logged with a date and time stamp.

#### Diagnostics (260-268)

These screens allow for

- Viewing all the analog inputs
- Ability to force 0-10 analog outputs to 0, 5, or 10 volts
- Ability to force 4-20 mA analog outputs to 4, 12, or 20 mA
- Viewing all the digital inputs
- Ability to force all digital outputs ON or OFF
- Special motor testing ability

#### IO Status (250)

- This screen displays the status of major inputs and outputs on the RCU.

#### Machine Hours (330)

- This screen shows statistics for the number hours of instrument operation.

#### Set IP Address (320)

If option supplied, the FCR network address is set here



## RHEOMETER SCREENS

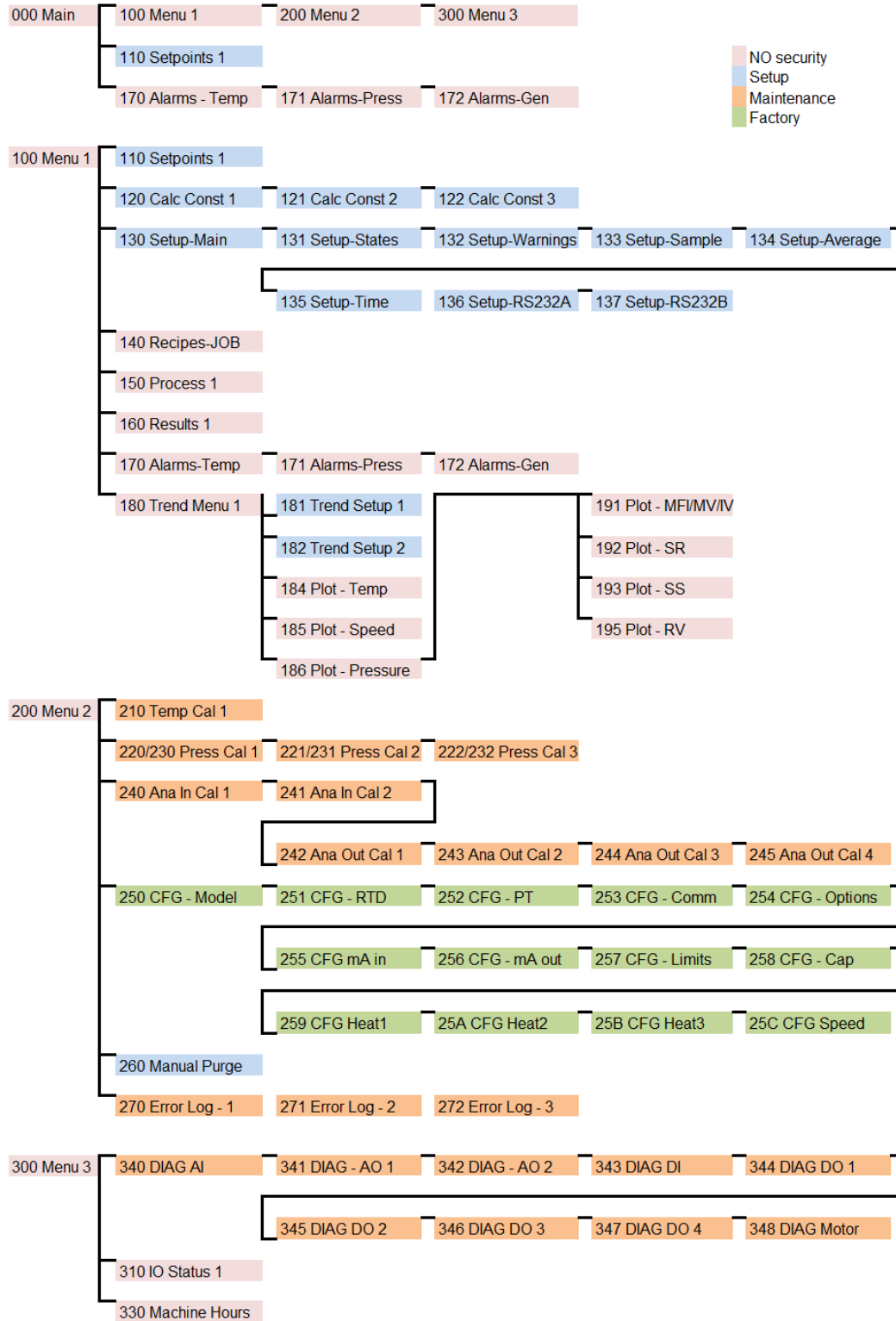

### Start-up Screen

The start-up screen is displayed for about 3 seconds on power up.

The PLC software version number, HMI software version number and the instrument serial number are useful information when calling for customer service. This information is also available in screen 250 CFG-Model.

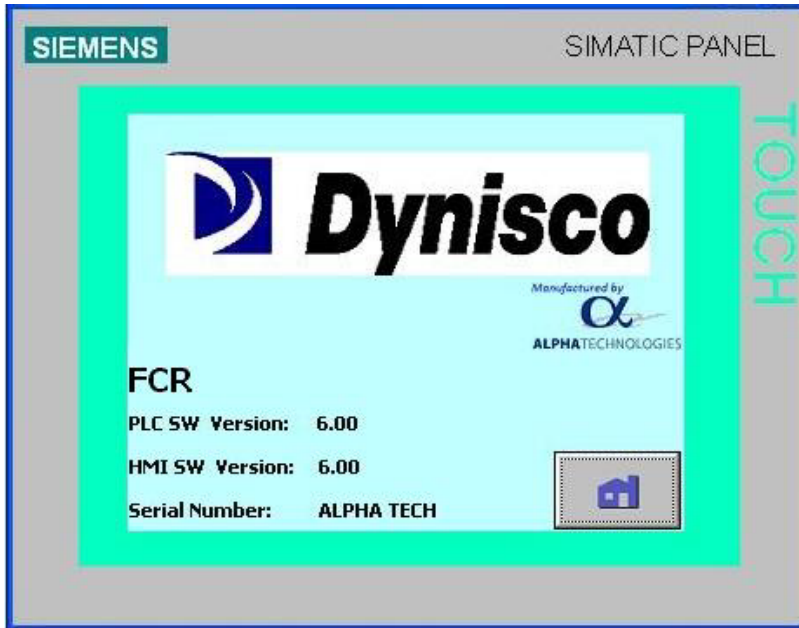

Main Screen (000) and Menu Screens (100,200,300)

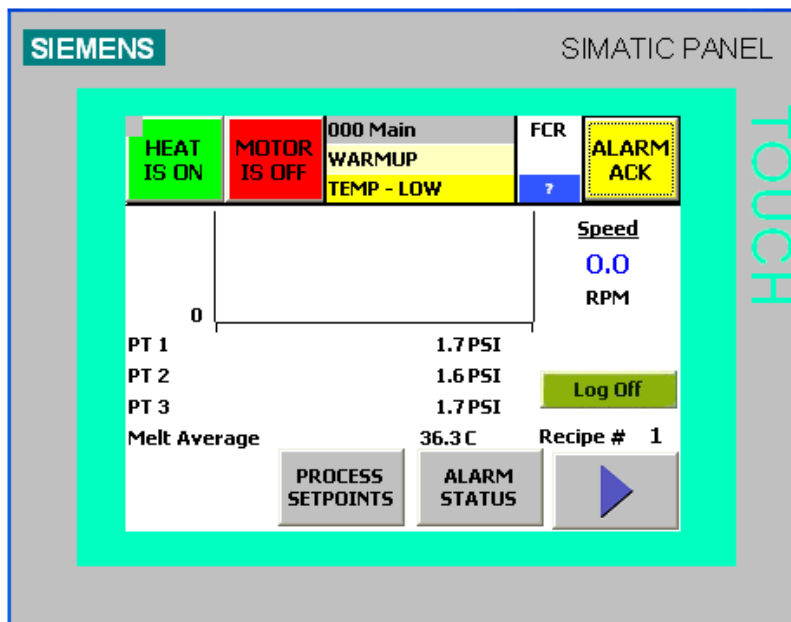



The above Main screen has been configured in screen 130 Setup-Main to display a trend graph. The graph and the data items displayed are selectable from a list of items in the Operator Setup. The trend graph shows the most recent 10 minutes of the selected parameter in real-time.

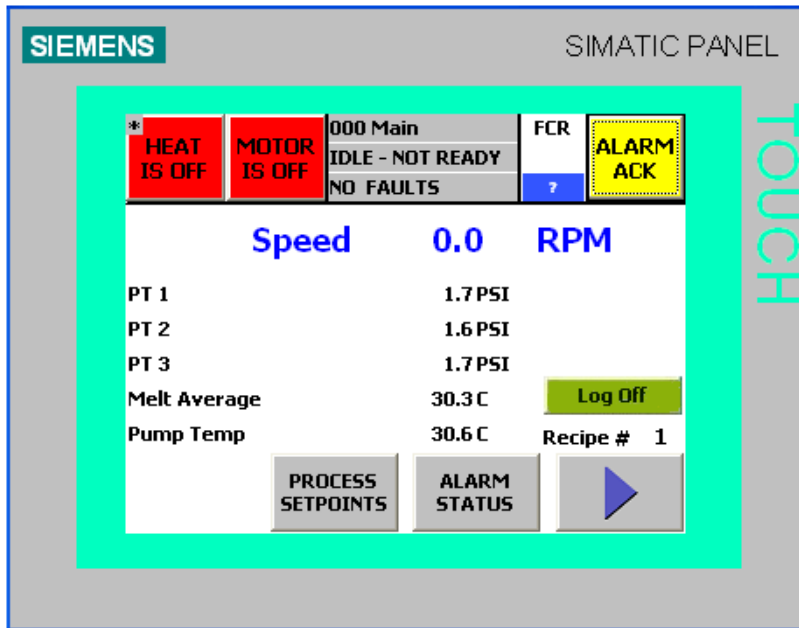

This Main screen has been configured in screen 130 Setup-Main to only display data items and no trend graph. The graph and the data items displayed are selectable from a list of items in the Operator Setup. The Log Off button is useful to prevent unauthorized operation or to change the level of access protection

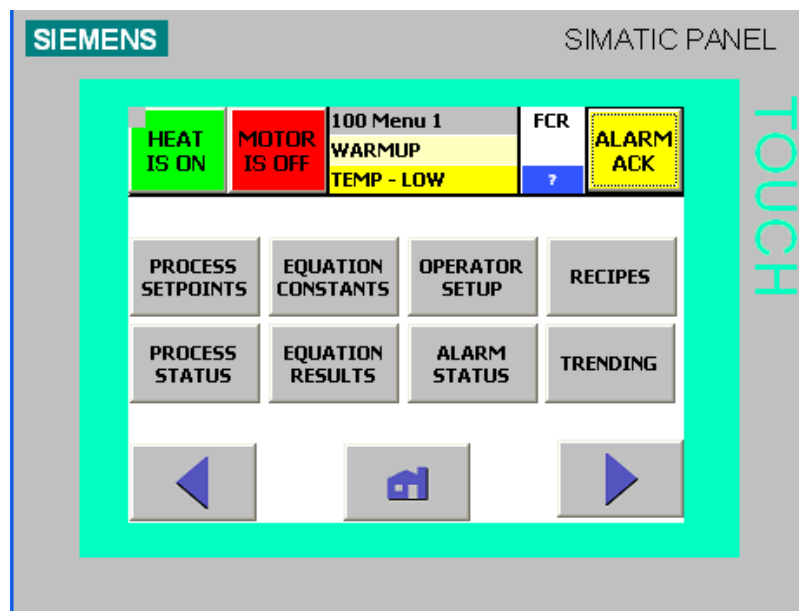

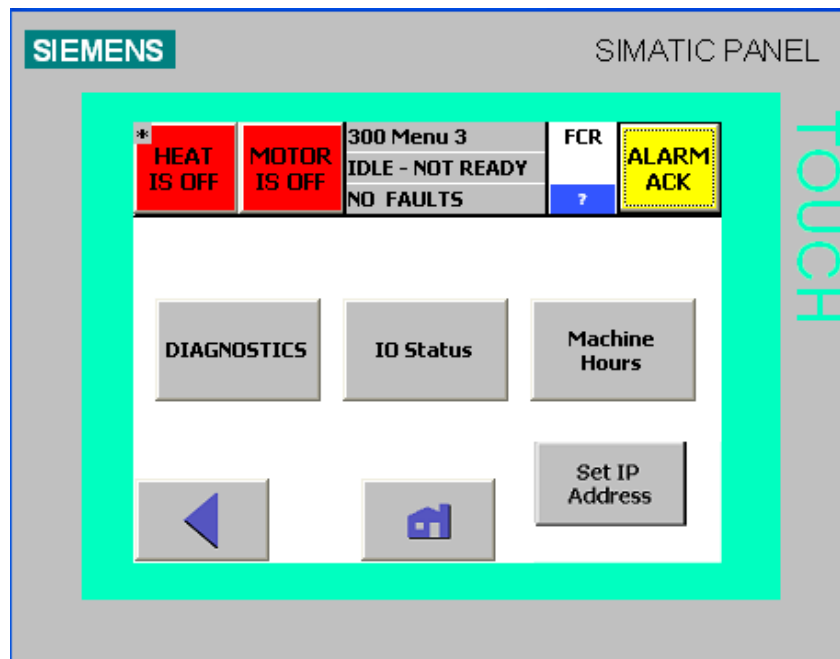
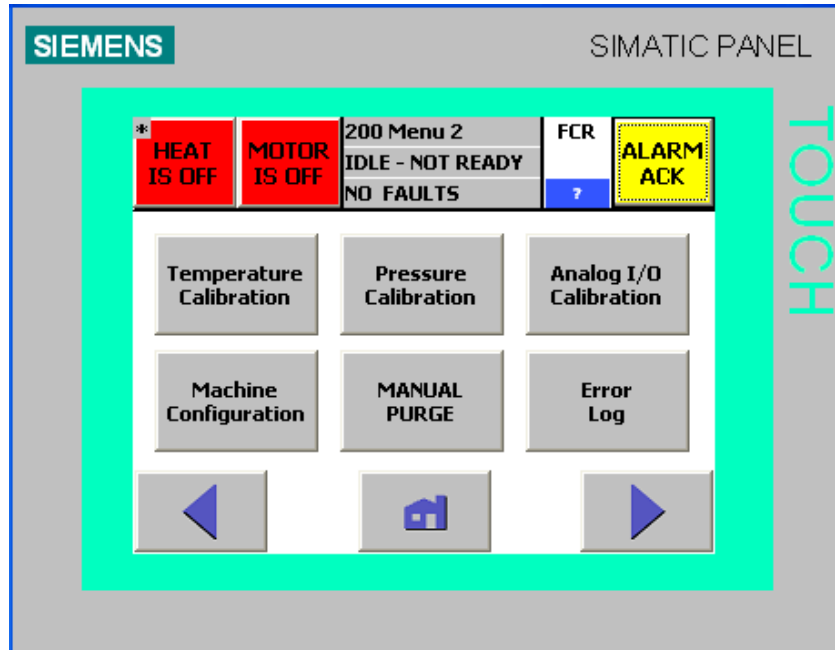

SET IP ADDRESS - This menu item is visible only when Ethernet is enabled in the configuration. The Ethernet address is set through this screen.



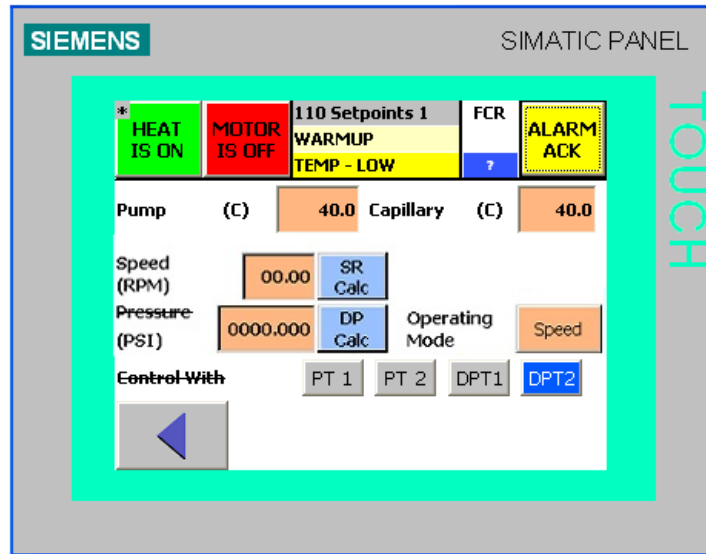

Process control setpoints

- Pump temperature
- Capillary temperature
- Speed while in the speed mode
- Pressure while in pressure mode

Speed – press this button to change from speed mode to pressure mode

Control With – select the pressure reading to use for the constant pressure control

PT1: pressure transducer 1

PT2: pressure transducer 2

DPT1: delta pressure 1 = pressure transducer 1 – pressure transducer 3

DPT2: delta pressure 2 = pressure transducer 2 – pressure transducer 3

RMT is ON/OFF – the rheometer is being controlled externally via the heat/motor enable discrete signals and the 4-20 mA inputs for setpoints.

MBUS is ON/OFF – the rheometer is being controlled via the Modbus communication port.

DP-DP is ON/OFF - the rheometer is being controlled via the Profibus DP-DP coupler.

ENET is ON/OFF - the rheometer is being controlled via the Ethernet communication port.

NOTE: The MBUS/DP-DP/ENET buttons are only visible if the desired communication module is installed in the rheometer. The RMT communications is configured in the Machine Configuration screen 253 CFG-Comm.

SR Calc & DP Calc – open calculators to determine operating speed from desired shear rate and operating pressure from the laboratory ASTM test weight.

Equation Constants (120-123)

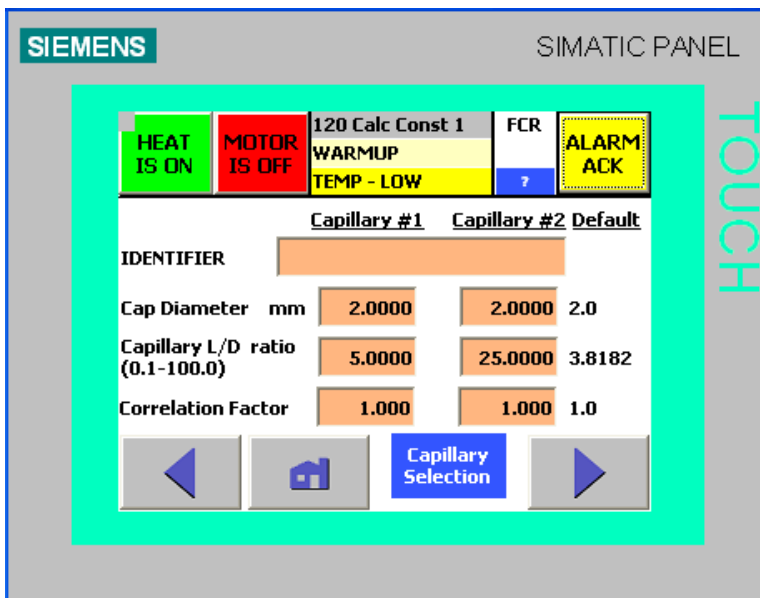

Cap Diameter: Diameter of the capillary die

Capillary L/D ratio: Capillary die length divided by the capillary diameter

Correlation Factor: Laboratory MFI divided by the Rheometer MFI (Corrects for any measurement differences between the laboratory and the online instrument). The default is 1.0

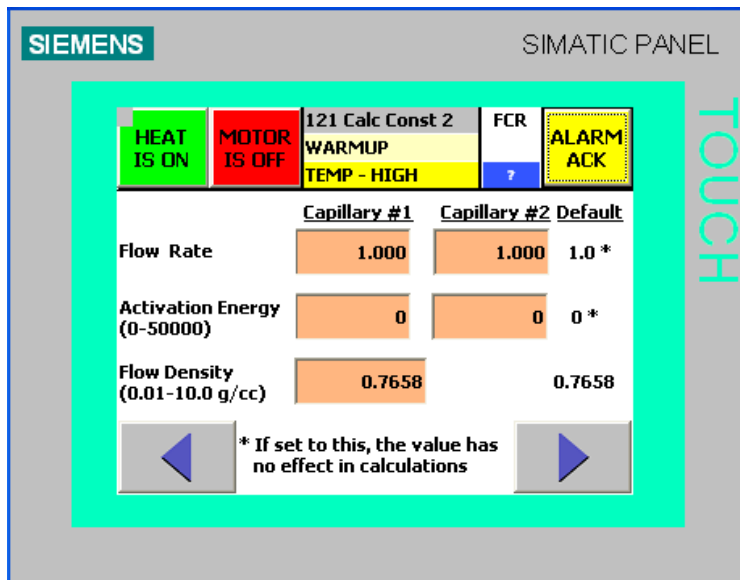

Flow Rate:  $MFR_{ref\_pressure} = (ref\_pressure/process\_pressure)^{1/Flow\_rate}$   
The default is 1.0

Activation Energy:

$$\text{Temp\_correction} = \text{EXP}(\text{act\_energy} * ((1.0/(\text{ref\_temp} + 273.15)) - (1.0/(\text{process\_temp} + 273.15))))$$

The default is 0.0

Flow Density: Material density in g/cc. Used for calculating the MFI

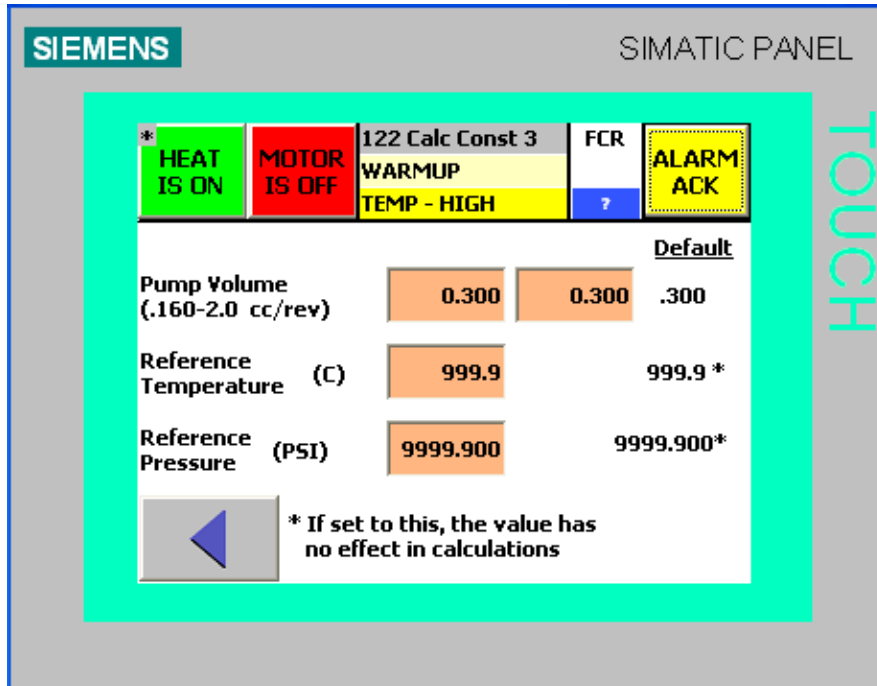

Pump Volume: Volume of the pump in cc/rev

Reference Temperature:

Temp\_correction = EXP(act\_energy \* ((1.0/(ref\_temp + 273.15)) - (1.0/(process\_temp + 273.15)))) The default value of 999.9 produces no temperature correction

Reference Pressure:

$$\text{MFI\_ref\_pressure} = (\text{ref\_pressure}/\text{process\_pressure}) ^{(1/\text{Flow\_index})}$$

The default value of 9999.9 produces no pressure correction

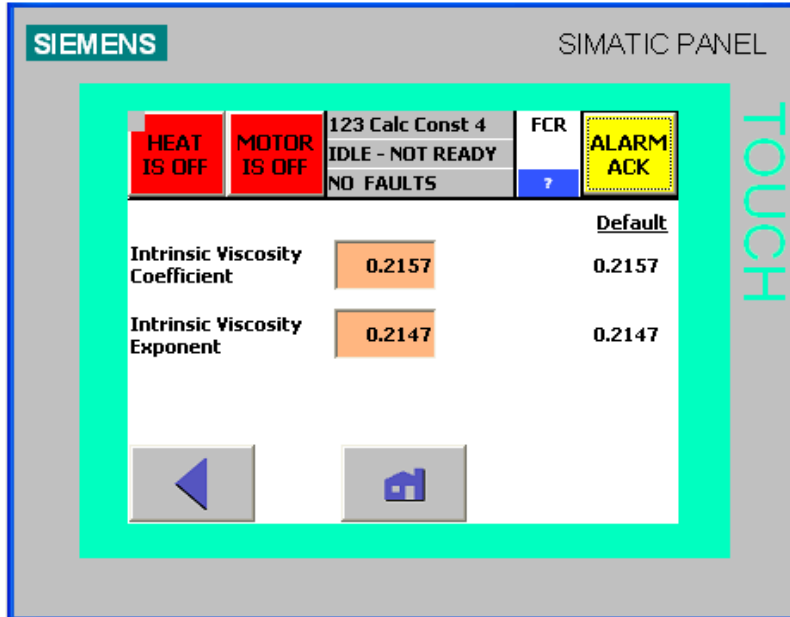

Intrinsic Viscosity Coefficient:

Intrinsic\_Viscosity (IV) = IV\_coef \* (melt\_viscosity ^^ IV\_exp), the default is 0.2157

Intrinsic Viscosity Exponent:

Intrinsic\_Viscosity (IV) = IV\_coef \* (melt\_viscosity ^^ IV\_exp), the default is 0.2147

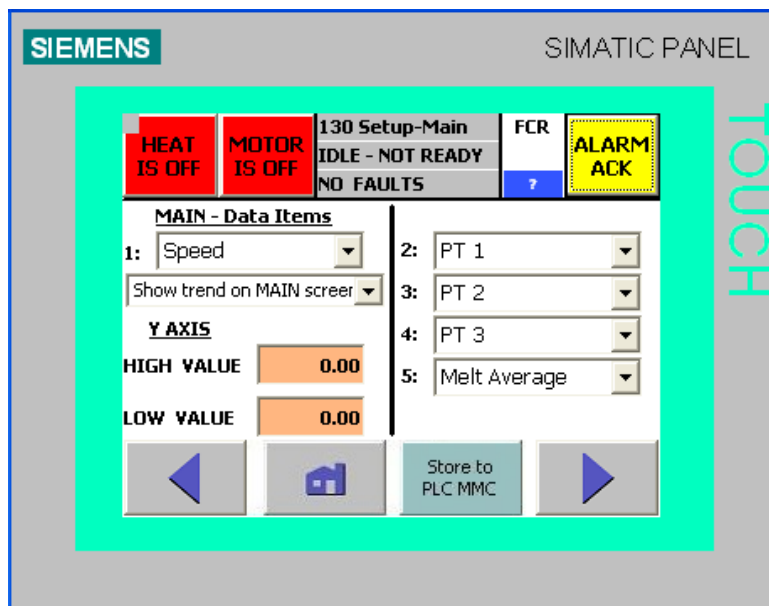

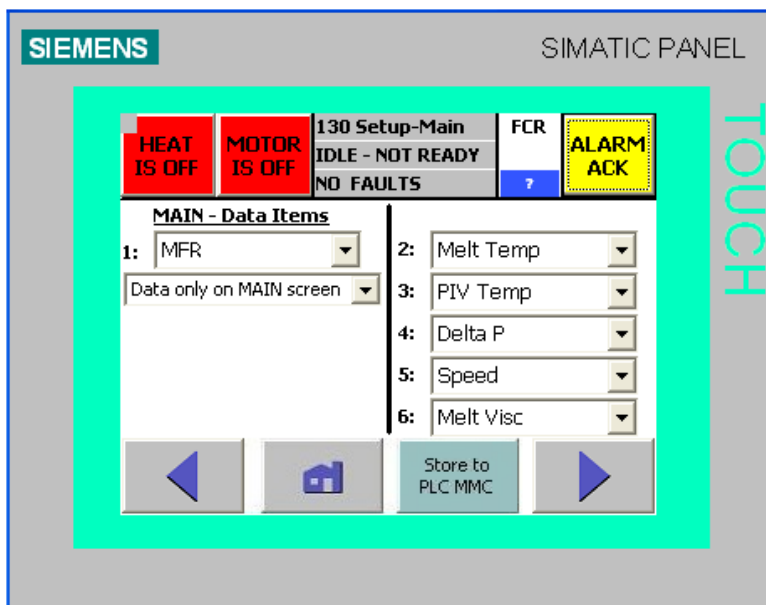

### MAIN – DATA ITEMS

Press the down arrow button on the right side of the “1:” box. A drop-down box contains the selections. Highlight the desired selection. Press the down arrow button to select whether to display the 10-minute trend graph for the selected item on screen 000 MAIN. The 5 or 6 items selected here will be displayed on the 000 Main screen. The choices include temperatures, pressures, pump speed, MFR, shear rate, shear stress, melt viscosity, relative viscosity, and intrinsic viscosity. Press the down arrow button on the right side of the 2 through 5 (6 if no trend) boxes to highlight the desired selection.

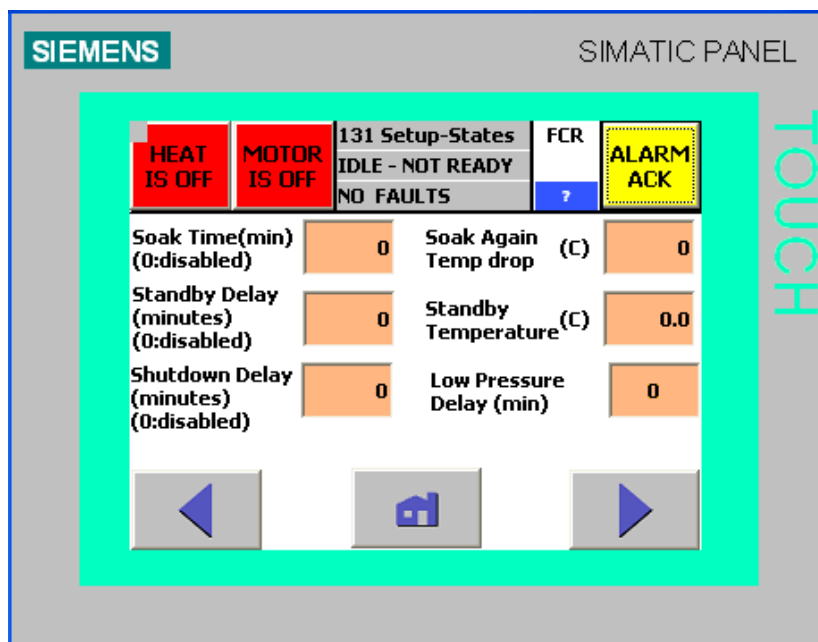



The Setup-States screen is used to configure the rheometer soak, standby, and shutdown conditions.  
SOAK (0: disabled)

The soak conditions are used to “soak” the material at a given temperature for a period of time before permitting the motor/pump to operate. On power-up, the soak time begins when there are no low temperature warnings. A soak will also be initiated if the temperature ever drops below the selected limit (temperature setpoint minus the soak again temp drop) for 1 minute. During the soak process, the instrument state will change to SOAK and the soak timer will be displayed. No motor enable button will be visible until the soak time has completed.

The soak process can be stopped by pressing the BYPASS SOAK button. This button appears during the soak process where the Motor enable/disable button is located.

STANDBY (0: disabled)

If the instrument is in an IDLE – READY state for the standby delay time, the instrument state changes to STANDBY. In the standby state, the temperature setpoint changes to the standby temperature. Press the EXIT Standby button to return to the process setpoint. The standby timer is displayed while in the IDLE-READY state.

SHUTDOWN (0: disabled)

If the instrument is in the Standby state for the shutdown delay time, the heat will be disabled and the state will change to IDLE – NOT READY. The shutdown timer is displayed while in the Standby state.

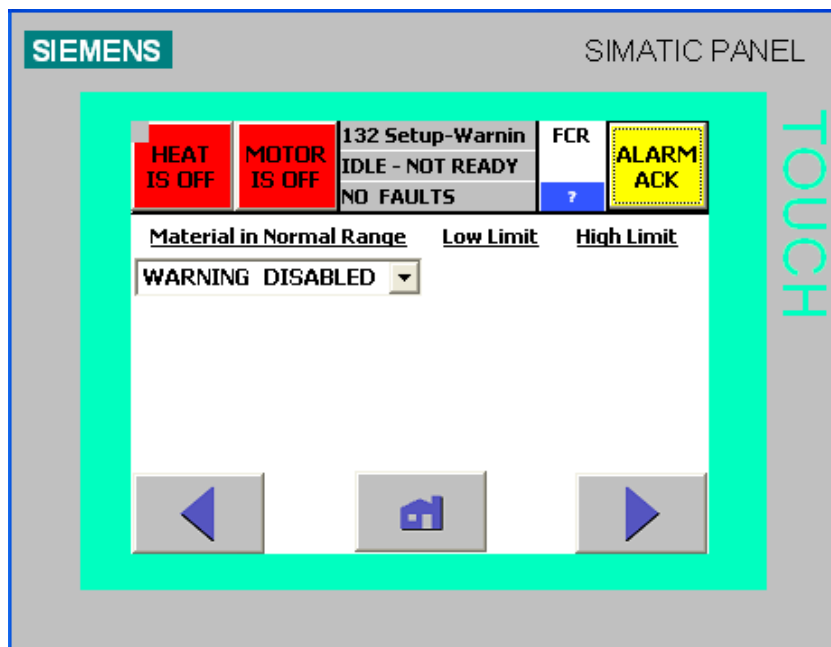



- Material in Normal Range selections
- WARNING DISABLED No material range check
- MFI WARNING
- MV WARNING
- IV WARNING
- RV WARNING
- MFI (2) WARNING
- MV (2) WARNING

The selected material property is normal when the property is within the given low and high limits. A warning message is displayed and the warning relay is activated when the limits are exceeded after the motor has been operating for over 30 seconds.

**Low Limit**

Lower limit for the selected item (MFI/MV/IV/RV)  
The low limit is ignored when the warning is disabled.

**High Limit**

High limit for the selected item (MFI/MV/IV/RV)  
The high limit is ignored when the warning is disabled.

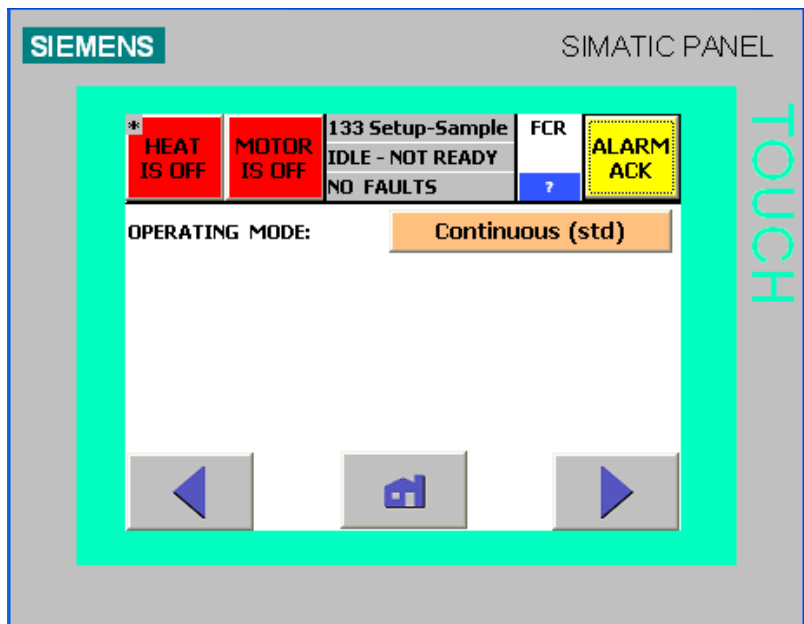

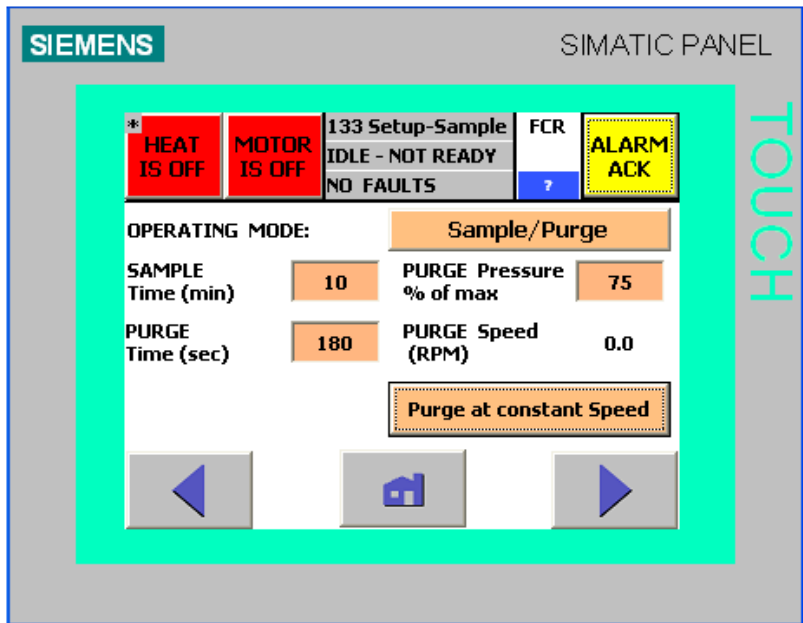

**OPERATING MODE:**

Continuous (standard mode of operation)

The rheometer operates continuously at the set speed while in constant speed mode. The rheometer operates continuously at the set pressure while in constant pressure mode.

**Sample/Purge**

The rheometer operates at a constant speed/pressure while sampling the material. After the sampling time, the rheometer changes to a higher speed/pressure to purge the existing material. During this purging process, the material properties

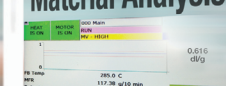
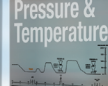

are not calculated and the last results are held constant on the display. This mode should only be used when there is a long transfer path from the process to the rheometer.

The Sample/Purge operating mode can be used when a faster response time is required. This is beneficial when the installation requires a long transfer length and the material requires a slow pump speed. In the Sample/Purge mode, the rheometer samples the material and calculates the material properties (MFI/Viscosity) for the set amount of time. After the sample time expires, the rheometer operates at a faster speed for the set amount of time to purge the transfer line of material and to provide fresh material to the rheometer. After the purge time expires, the rheometer returns to the material sampling operation. While sampling the material, the MFI and viscosity parameters are calculated and updated on the HMI. While purging, the MFI and viscosity parameters are not calculated and the last calculated value is “frozen” on the display.

Sample Time – range 3-32767 min

Amount of time for the rheometer to operate normally

Purge Time -- range 15-900 sec

Amount of time for the rheometer to operate at a higher speed with no MFI or viscosity updates

Purge Pressure % of max -- range 5 to 90% of the maximum for transducer 1

Pressure setpoint for purging at a constant pressure

Purge Speed -- range 3 RPM to the maximum allowable

Speed setpoint for purging at a constant speed

Purge at constant Speed / Purge at constant Pressure

Purge at constant Speed -- purge at the purge speed setting

Purge at constant Pressure -- purge at the constant pressure determined by the  
purge pressure % of max

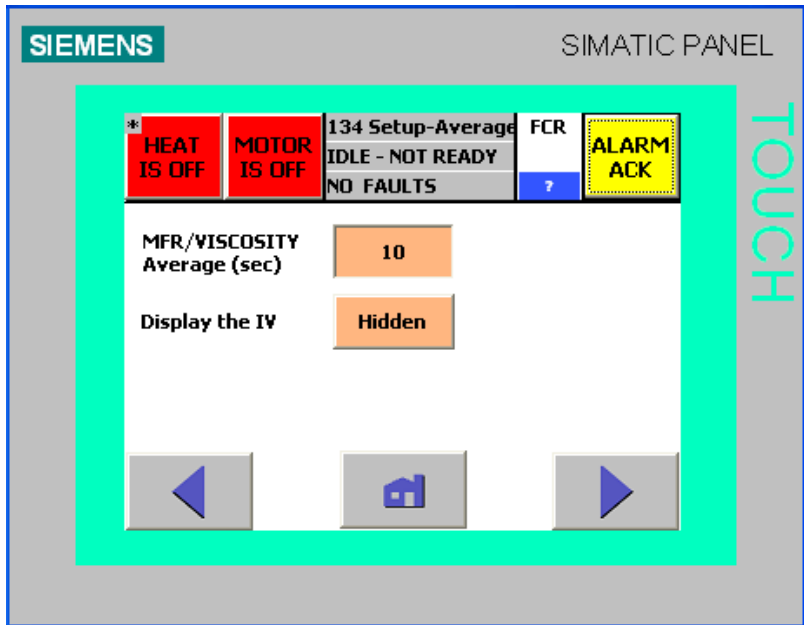

MFR/VISCOSITY Average (sec) – range 2-1800 seconds, The MFr, Melt Viscosity, and Intrinsic Viscosity measurements are averaged over the time period.

Display the IV – Visible: IV parameters are visible; Hidden: IV parameters are hidden

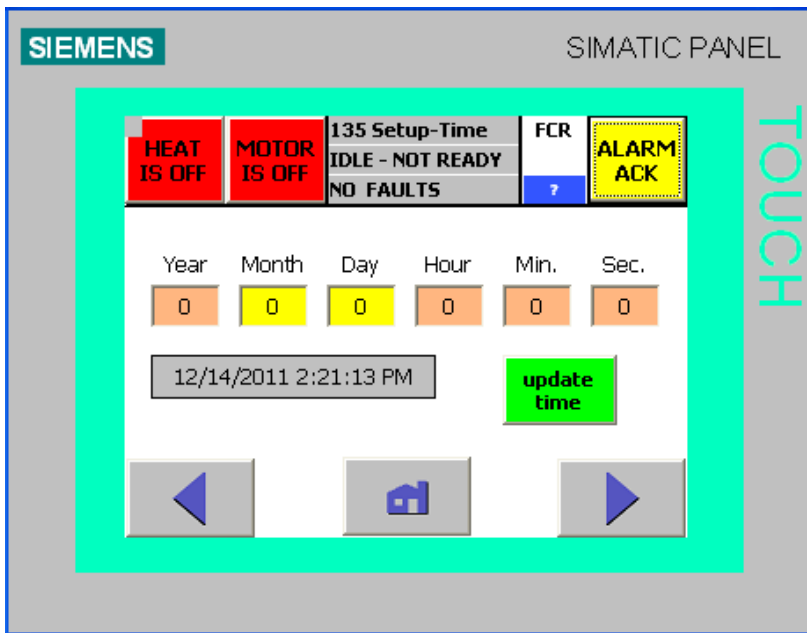

The date and time entered are used in the PLC and in the HMI. The time is used for all trend graphs and for the error log. To set the time: press each box to enter the year/month/day/hour/min value; press the Update Time box, the new time is then visible in the grayed box.



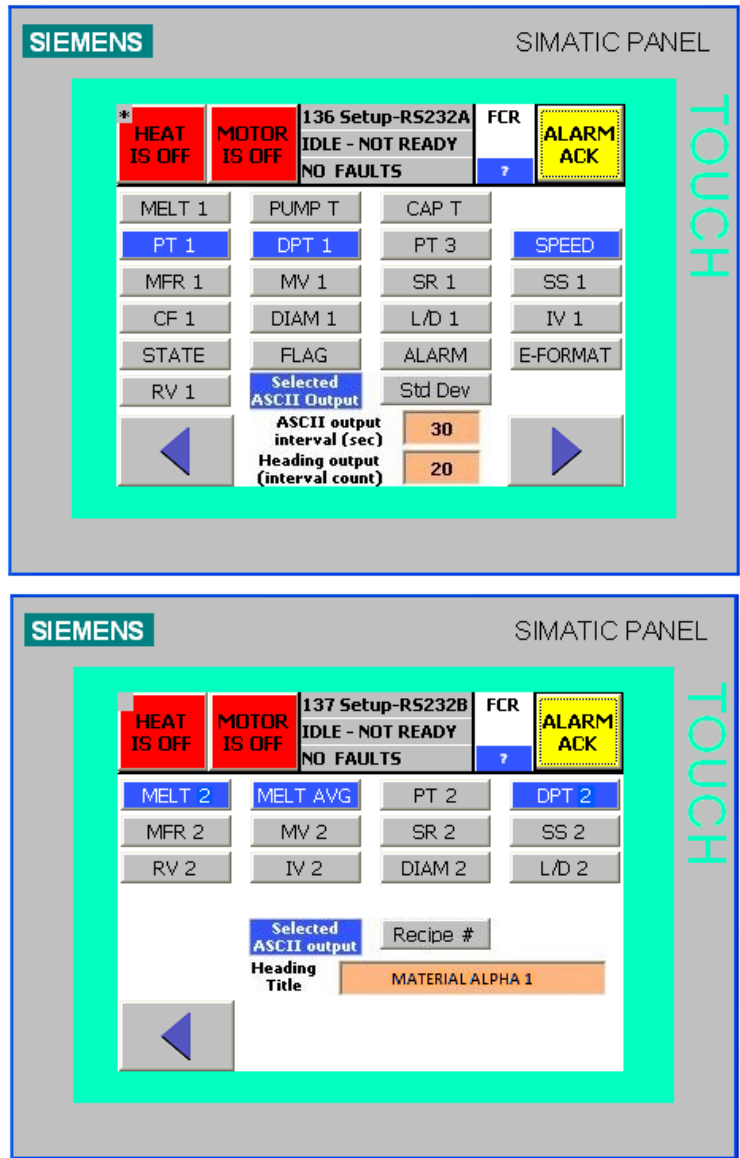

The rheometer is capable of transmitting rheometer data over an RS-232 communication port at a user set interval. A maximum of 25 data items can be selected:  
 The RS-232 (ASCII) output is factory set at 9600 baud, no parity, 8 data bits, 1 stop bit, and no flow control (9600:N:8:1)  
 Select the data items in screens 136 that are to be communicated by pressing the button for the item. Selected items are shown in blue. Press

the ASCII output interval button to enter the desired interval. An interval of 0 seconds disables the output. The maximum interval is 28800 seconds (8 hours). A header can be output at the set interval count. The header includes the selected output items in proper order. A setting of 0 disables the header and 20 sets the header to be output every 20th data output. The header can include a title with up to twenty characters. A leading space or blank will disable the title output.

The data is output in text format and can be captured with a terminal program or on a flash drive if the optional datalogger is supplied. The file can be imported into Excel as a space delimited text file.

The standard format for the data is shown below:  
mm-dd-yy hh:mm:ss +xxxx.x +xxxx.x ...

The E-format is required to communicate values greater than 32767. The E-format is shown below:  
< mm-dd-yy hh:mm:ss +1.0000000E+00 +1.0000000E+00 >

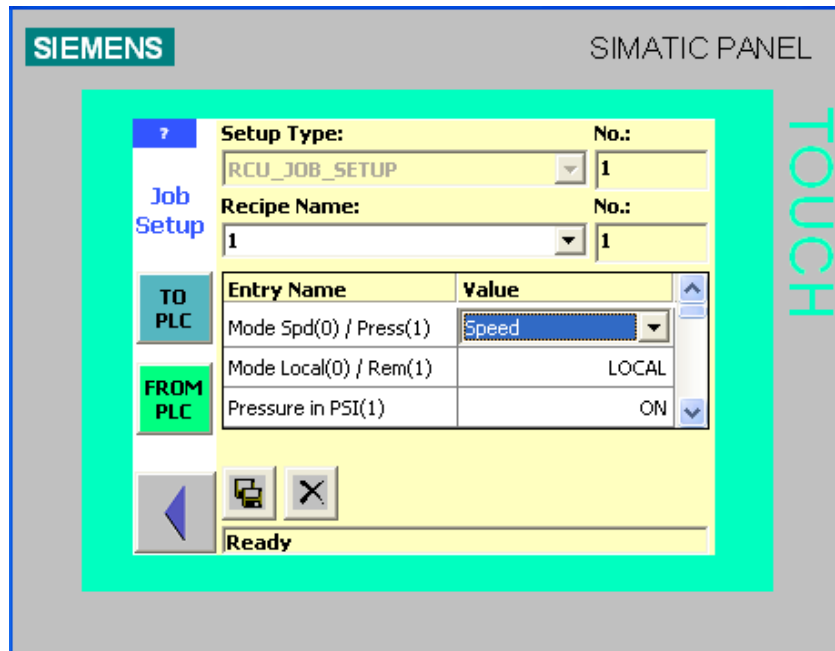

Recipe Name - Used to add new recipes or recall a previously saved recipe files  
Entry Name – List of stored values within a recipe, this list is inclusive of all possible recipe parameters and some will not be applicable

**TO PLC** - Sends the currently viewed HMI recipe to be stored in the PLC

**FROM PLC** - Reads recipe stored in the PLC into the current HMI recipe

- Saves the current recipe in a file, the file name will be prompted for and if a file of that name exists, a prompt will ask if it is to be overwritten

- Permanently removes a stored recipe file, a prompt will ask if the action is to be performed

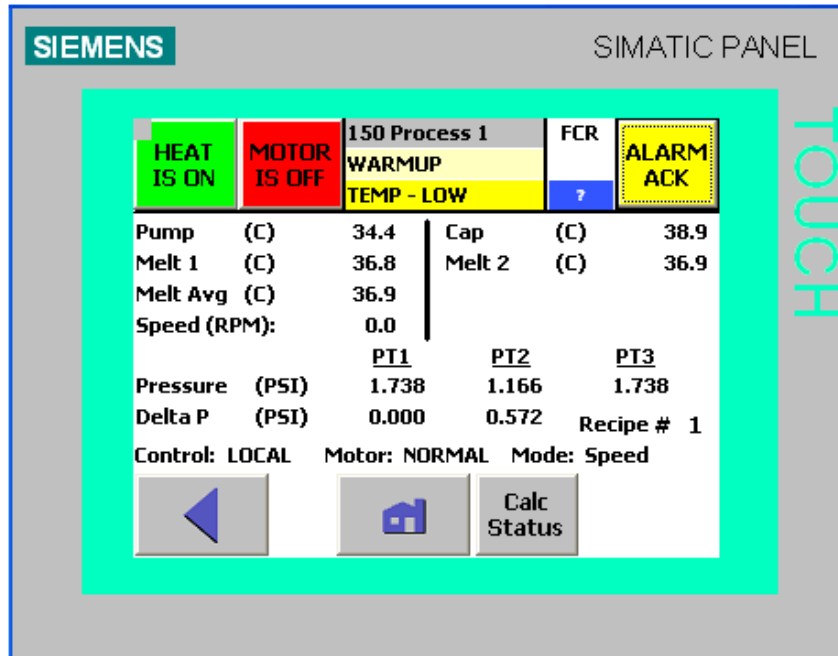

All items on screen 150 are view only. Temperature, pressure, and speed readings are calibrated readings.  
 Control: LOCAL - all instrument control is performed at the HMI  
 REMOTE - a remote station can perform control  
 Motor: – NORMAL  
 FAULT  
 Mode: - Pressure – the motor speed is controlled to provide a constant pressure  
 Speed – the motor is controlled to provide a constant speed

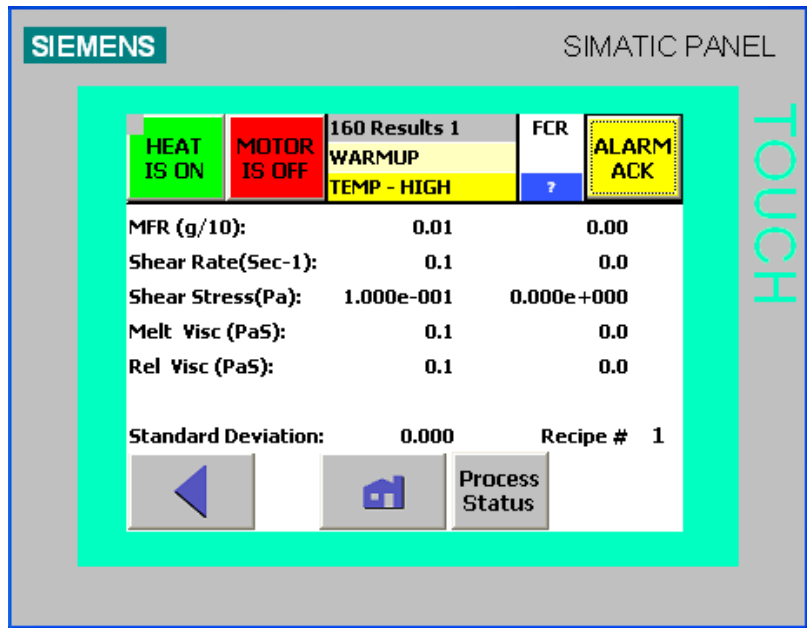

All items on screen 160 Results 1 are view only.

The equations used for the rheometer calculations are shown below.

$$TEMP\_CORR = e^{\left(\frac{E_a}{R}\right) \left( \frac{1}{REF\_TEMP + 273.15} - \frac{1}{MELT\_TEMP + 273.15} \right)}$$

$$MI\_BASIC = 10 * PUMP\_SPEED * PUMP\_VOL * DENSITY * CF * \left( \frac{1}{TEMP\_CORR} \right) * \left( \frac{0.0825}{CAP\_DIA} \right)^3$$

$$MELT\_INDEX = MI\_BASIC * CAP\_SHIFT * \left( \frac{REF\_PRESS}{PRESSURE} \right)^{\left( \frac{1}{FLOW\_INDEX} \right)}$$

$$SHEAR\_STRESS = \left( \frac{1723.69 * PRESSURE}{L/D} \right)$$

$$SHEAR\_RATE = \left( \frac{0.01036 * PUMP\_SIZE * PUMP\_SPEED}{CAP\_DIA^3} \right)$$

$$VISCOSITY = TEMP\_COR * \left( \frac{SHEAR\_STRESS}{SHEAR\_RATE} \right)$$

### Alarm Status (screens 170-172)

The following status conditions are displayed in the status screens:

- Normal (green) conditions are within the normal limits
- Low (yellow) warning that condition is below the lower limit
- Low (red) fault that condition is low
- High (yellow) warning that condition is above the upper limit
- High (red) fault that condition exceeds high limits
- Fault (red) fault that sensor is faulty or disconnected
- Alarm (red) fault caused by an alarm condition

Warning conditions activate the warning output relay. The motor/pump cannot be enabled while warnings are present. Warnings do not need to be acknowledged. Warning messages clear when the condition has returned to normal.

Fault conditions activate the fault output relay. The motor/pump cannot be enabled while faults are present. The heat cannot be enabled when a high temperature fault is present. Faults need to be acknowledged. Faults occurrences get date and time stamped and recorded in the screen 270 Error Log-1.

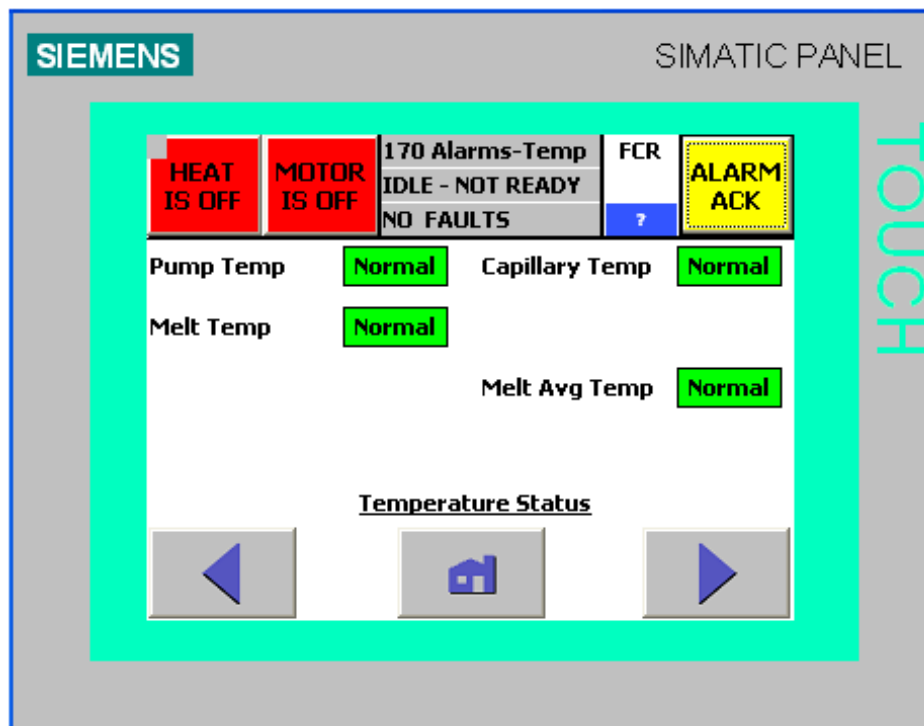



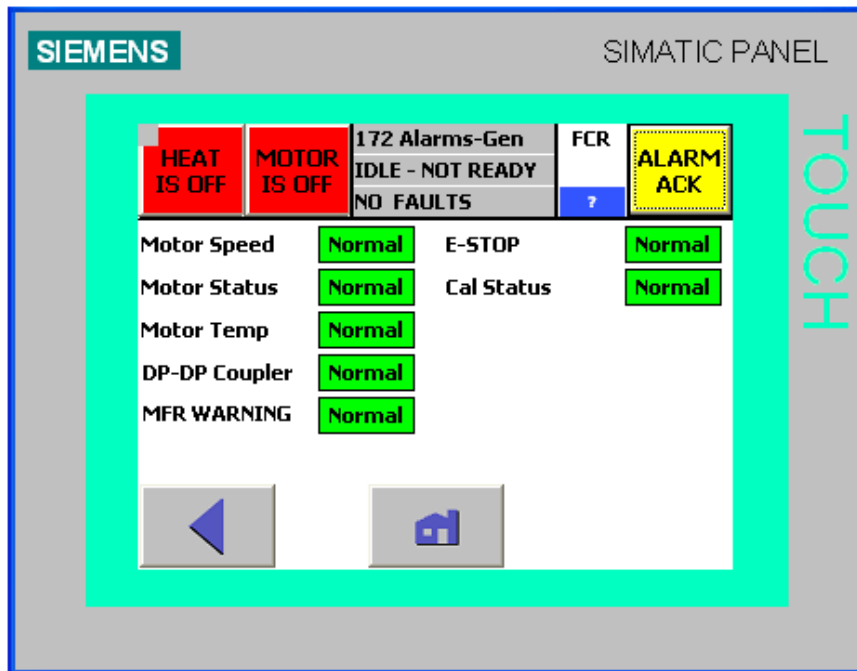
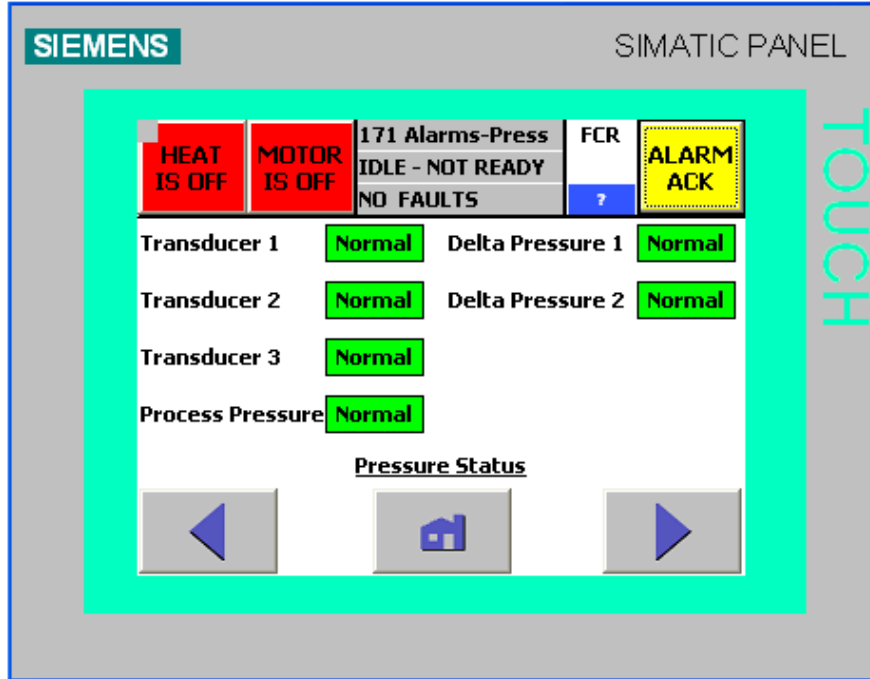

DP-DP coupler - OFF: Coupler installed and disabled warning; Fault: No DP-DP coupler "ALIVE" signal detected from the DCS

Material Warning - Low Warning: Material property less than the normal range; High Warning:

Material property exceeds the normal range; the normal range is set on screen 132.



### Trending Graphs (180-199)

Trending screens graph data over a rolling 10 or 60-minute period of time. For example, Speed-10 graphs the speed over a 10-minute window while Speed-60 graphs the speed over a 60-minute window.

Set the Y-axis limits in the TREND SETUP screens (181-183). Set the Y-axis lower limit less than the lowest data value to be displayed. Set the Y-axis high limit greater than the highest data value to be displayed. This ensures that the data will be viewable in the graph.

Press the appropriate button to view the following graphs:



- |                        |                        |
|------------------------|------------------------|
| Temperature-10 minutes | Temperature-60 minutes |
| Speed-10 minutes       | Speed-60 minutes       |
| Pressure-10 minutes    | Pressure-60 minutes    |
| MFR-10 minutes         | MFR-60 minutes         |
| SR-10 minutes          | SR-60 minutes          |
| SS – 10 minutes        | SS – 60 minutes        |
| MV-10 minutes          | MV-60 minutes          |
| RV-10 minutes          | RV-60 minutes          |
| IV-10 minutes          | IV-60 minutes          |

While viewing a trend graph, press the left/back arrow to return to the trend menu. Press the right arrow to proceed to the next trend graph.

The trend menus are shown on screens 180.

The trend setup conditions are shown on screens 181-182.

The trend graphs are shown on screens 184-186 and 191-196.

When using the 60 minute trend time axis, the  and  buttons will contract and expand, respectively, the time axis.

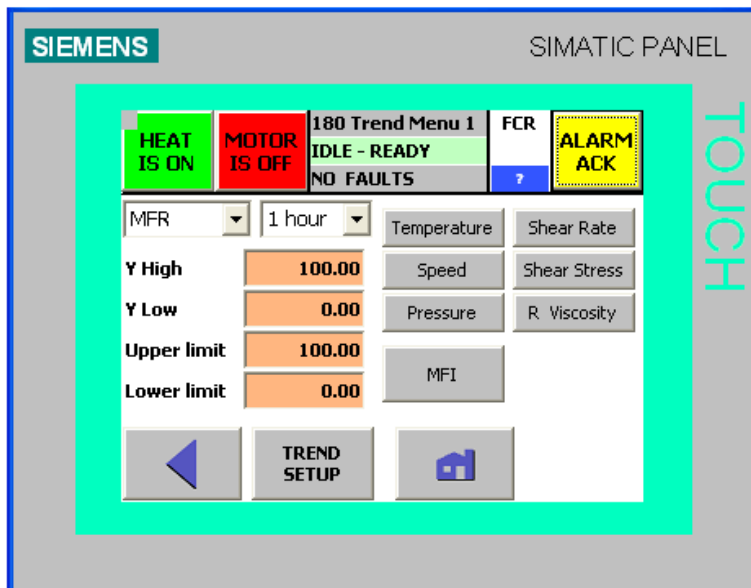

**SIEMENS** SIMATIC PANEL

* HEAT IS OFF	MOTOR IS OFF	181 Trend Setup 1	FCR	ALARM ACK
		IDLE - NOT READY		
		NO FAULTS	?	

**RHEOMETER**

	Y low	Y high
Temperature (C)	20.0	60.0
Speed (RPM)	0.0	20.0
Pressure	0.0	15.0

TOUCH

**SIEMENS** SIMATIC PANEL

* HEAT IS OFF	MOTOR IS OFF	182 Trend Setup 2	FCR	ALARM ACK
		IDLE - NOT READY		
		NO FAULTS	?	

**RHEOMETER**

	Y low	Y high
Shear Rate (sec-1)	0	200
Shear Stress (Pa)	0	100000
R Viscosity (PaS)	0	10000

TOUCH

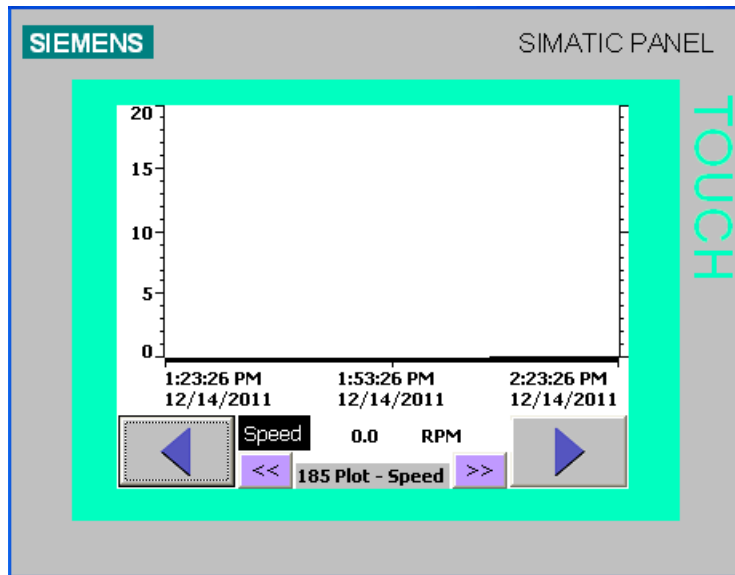
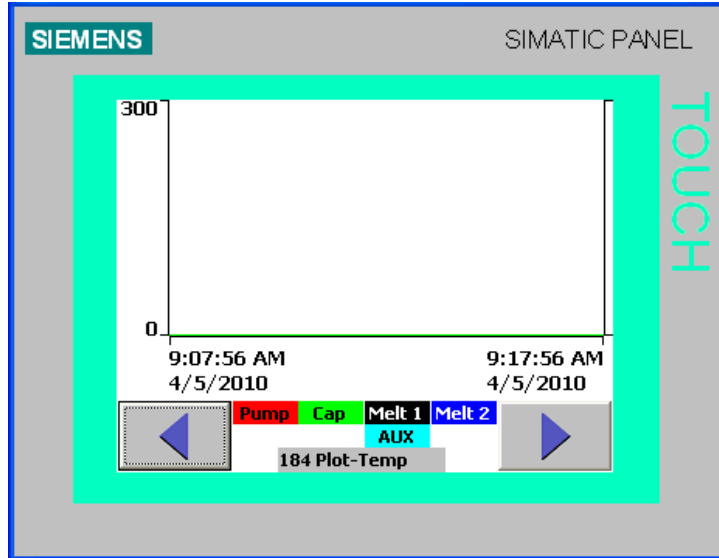

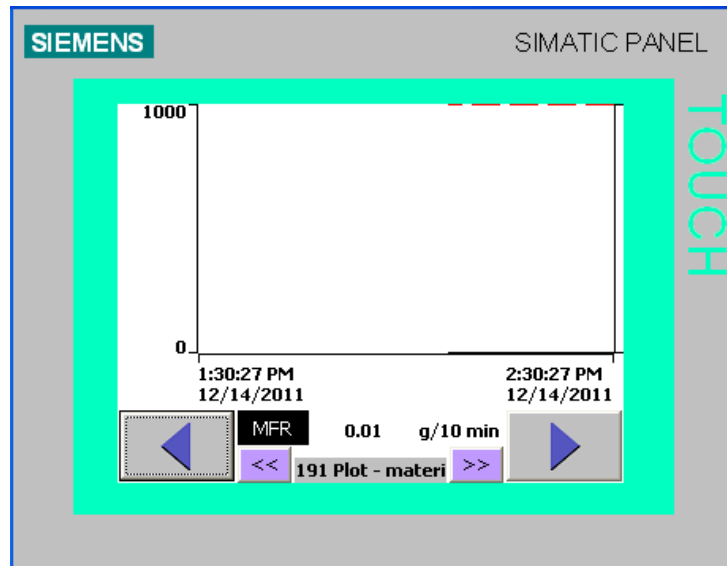
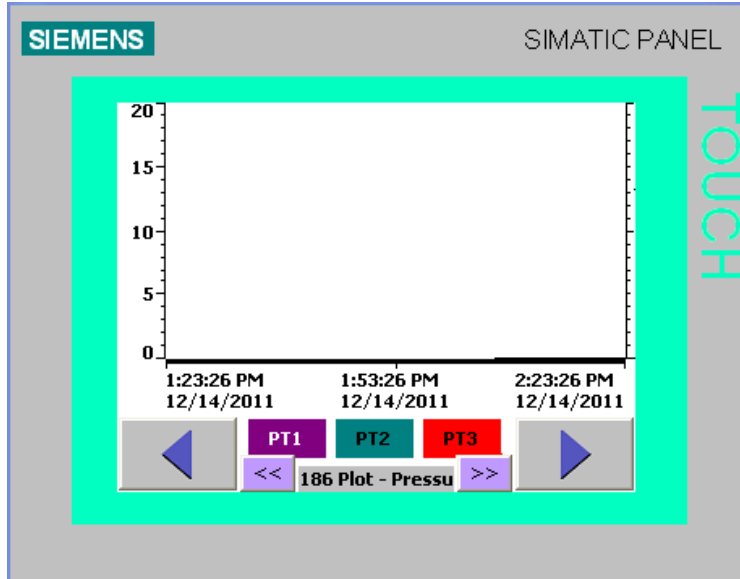



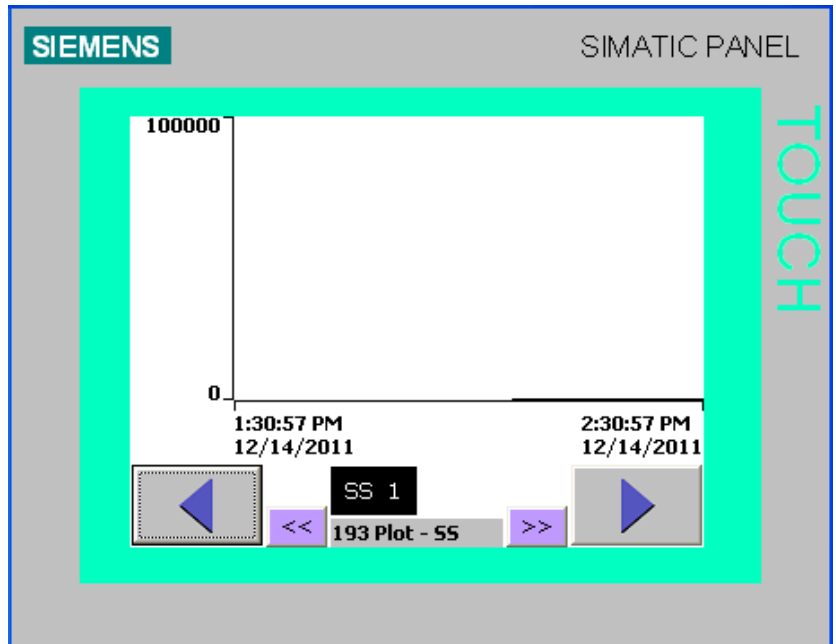
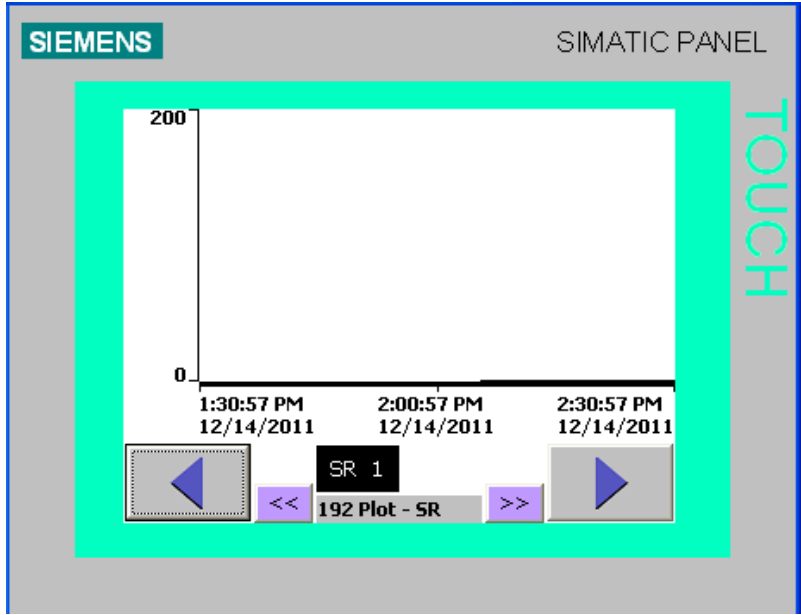

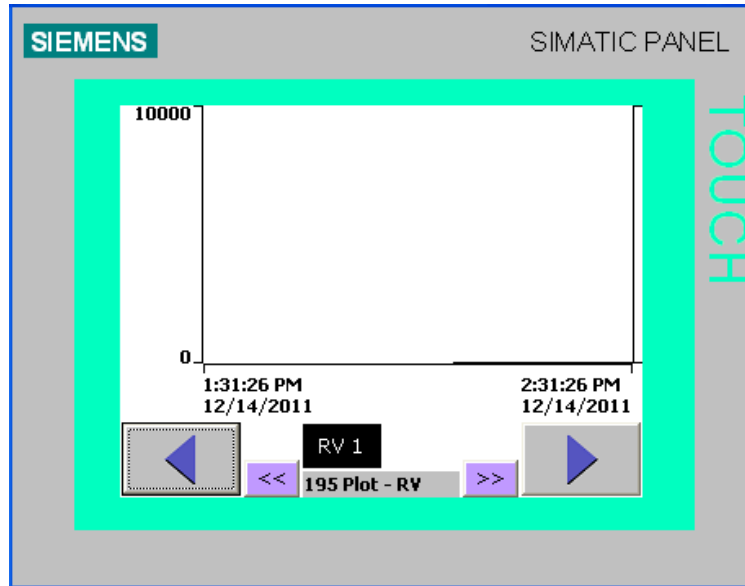

### Temperature Calibration (210-211)

Calibrating a temperature measurement is performed by entering a positive or negative offset to the raw temperature measurement. Enter an offset for the RTD such that the calibrated value on the screen matches the measuring device. Press the default temperature calibration button to zero the offset values

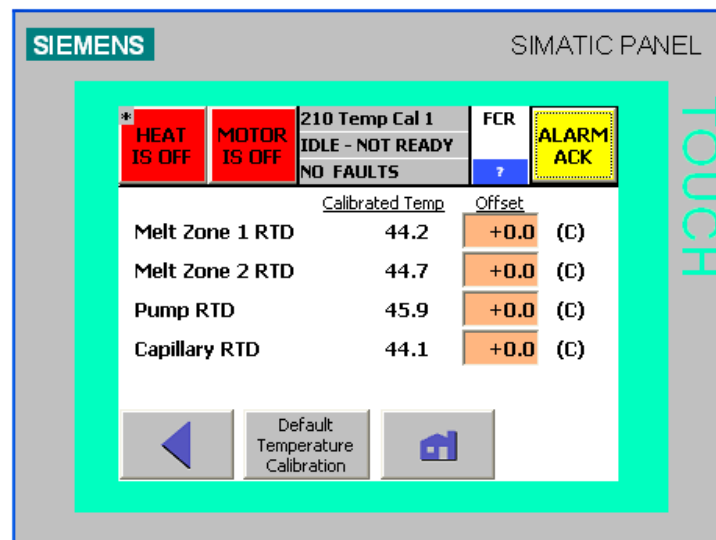

### Pressure Calibration (220-222, 230-232)

Each pressure transducer must be calibrated individually. Pressure transducers can be calibrated in any of three different ways. These are Default, Automatic Cal, and User Cal. The three cal screens are functionally identical except for the transducer number, 231 Press Cal 1 for PT1, 232 Press Cal 2 for PT2 and 233 Press Cal3 for PT3.

Default Pressure Calibration – press the Default Settings button

Low point 0.0 mV 0.0 PSI

High point 33.3 mV maximum PSI

Automatic Pressure Calibration – press the Automatic Cal button

The automatic calibration process takes about 15 seconds.

The pressure transducers must be at ambient pressure for accurate results.

The heat must be enabled with no temperature warnings to perform the Auto Cal.

Automatic Calibration utilizes a precision resistor within the transducer.

User/manual Calibration –

mV readings and the associated pressure are manually entered for the two pressure data points. This method is the most accurate.

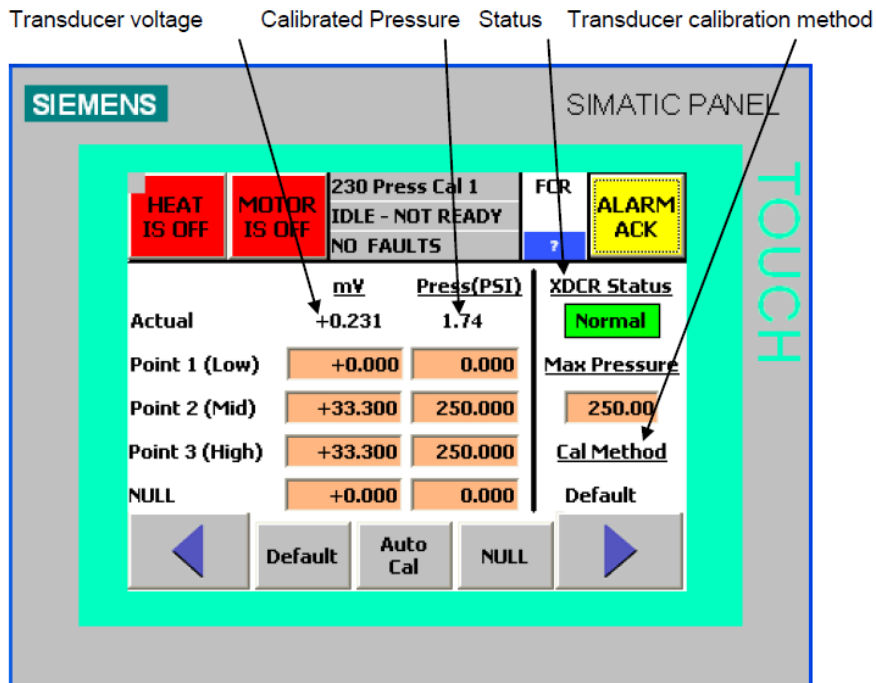

Analog I/O Calibration (240-245)

CAUTION: AI5 (speed) and AO1(0-10V) should only be calibrated by a trained service person! Poor calibration will cause errors in calculations and may damage the motor and drive.

Convert an analog (4-20 mA) input to a rheometer process setpoint

1. Select the process setpoint to be set by the analog input on screen 315 CFG mA in.
2. Install the analog inputs for process control by setting 4-20 mA inputs enabled in screen 313 CFG-Comm.
3. Scale the analog input on screen 241 Ana In Cal 2. Set the 4 mA value and the 20 mA value. For example, 4 mA represents 0.0 C and 20 mA represents 100.0 C.
4. Enable the analog inputs in screen 110 Setpoints 1 by setting RMT is ON
5. If necessary, calibrate the analog input on screen 241 Ana In Cal 2 such that the actual mA on the HMI matches the DCS analog output mA.

Convert a rheometer process value to an analog (4-20 mA) output

1. Select the process parameter to output on screen 316 CFG mA out.
2. Scale the analog input on screen 241 Ana In Cal 2. Set the 4 mA value and the 20 mA value. For example, 4 mA represents 0.0 C and 20 mA represents 100.0 C.
3. If necessary, calibrate the analog output on screens 242-244 Ana Out Cal.

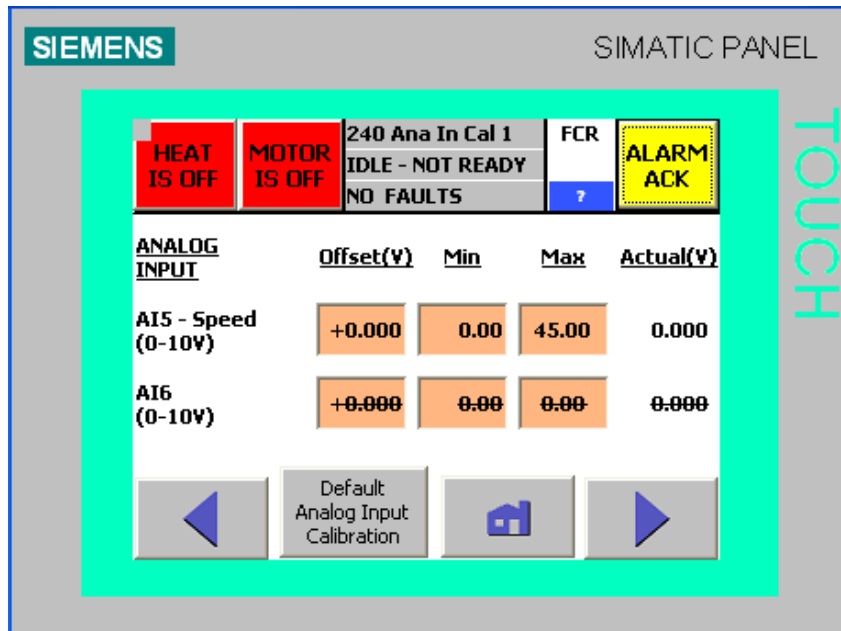

AI5 - Speed is set at the factory.  
AI6 - Not applicable for the FCR

**SIEMENS SIMATIC PANEL**

**TOUCH**

<b>* HEAT IS OFF</b>	<b>MOTOR IS OFF</b>	241 Ana In Cal 2	FCR	<b>ALARM ACK</b>
		IDLE - NOT READY		
		NO FAULTS	?	

<u>ANALOG INPUT</u>	<u>Offset (mA)</u>	<u>4 mA Value</u>	<u>20 mA Value</u>	<u>Actual (mA)</u>
Speed (RPM)	+0.000	0.0	48.0	0.000
Temperature	+0.000	0.0	80.0	0.000

Default Analog Input Calibration

4-20 mA inputs are calibrated and scaled in screen 241. The analog inputs shown were selected in screen 255 CFG – mA in.

Offset(mA) Used to calibrate the 4-20 mA input signal such that the Actual mA matches the mA output of the DCS.

4 mA Value Used to scale the 4-20 mA input. For example, 4 mA may represent a temperature setpoint of 0.0 C

20 mA Value Used to scale the 4-20 mA input. For example, 20 mA may represent a temperature setpoint of 60.0 C

**SIEMENS SIMATIC PANEL**

**TOUCH**

<b>* HEAT IS OFF</b>	<b>MOTOR IS OFF</b>	242 Ana Out Cal 1	FCR	<b>ALARM ACK</b>
		IDLE - NOT READY		
		NO FAULTS	?	

<u>ANALOG OUTPUT</u>	<u>Offset (V/mA)</u>	<u>Min</u>	<u>Max</u>	<u>Actual (V or mA)</u>
A01 - MSC (0-10V)	+0.000	0.00	40.00	1.275
Speed (RPM)	+0.000	0.00	48.00	0.000

Default Analog Output Calibration



A01 – (010V) is factory set to control the motor speed output.

4-20 mA outputs are calibrated and scaled in screens 242-244. The analog outputs shown in screens 242-244 were selected in screen 316 CFG – mA out.

Offset(mA) Used to calibrate the 4-20 mA output signal

4 mA Value Used to scale the 4-20 mA output. For example, 4 mA may represent a Speed of 0.0 RPM.

20 mA Value Used to scale the 4-20 mA output. For example, 20 mA may represent a Speed of 80 RPM.

**SIEMENS** SIMATIC PANEL

**TOUCH**

<b>HEAT IS OFF</b>	<b>MOTOR IS OFF</b>	243 Ana Out Cal 2	FCR	<b>ALARM ACK</b>
		IDLE - NOT READY	?	
		NO FAULTS		

ANALOG OUTPUT	Offset (mA)	Min	Max	Actual (mA)
PT 1	+0.000	0.00	250.00	0.000
PT 2	+0.000	0.00	250.00	0.000

Default Analog Output Calibration

**SIEMENS** SIMATIC PANEL

**TOUCH**

<b>* HEAT IS OFF</b>	<b>MOTOR IS OFF</b>	244 Ana Out Cal 3	FCR	<b>ALARM ACK</b>
		IDLE - NOT READY	?	
		NO FAULTS		

ANALOG OUTPUT	Offset (mA)	Min	Max	Actual (mA)
PT 3	+0.000	0.00	250.00	0.000
Melt Average	+0.000	0.00	80.00	0.000

Default Analog Output Calibration

Machine Configuration (250 - 259, 25A - 25C)

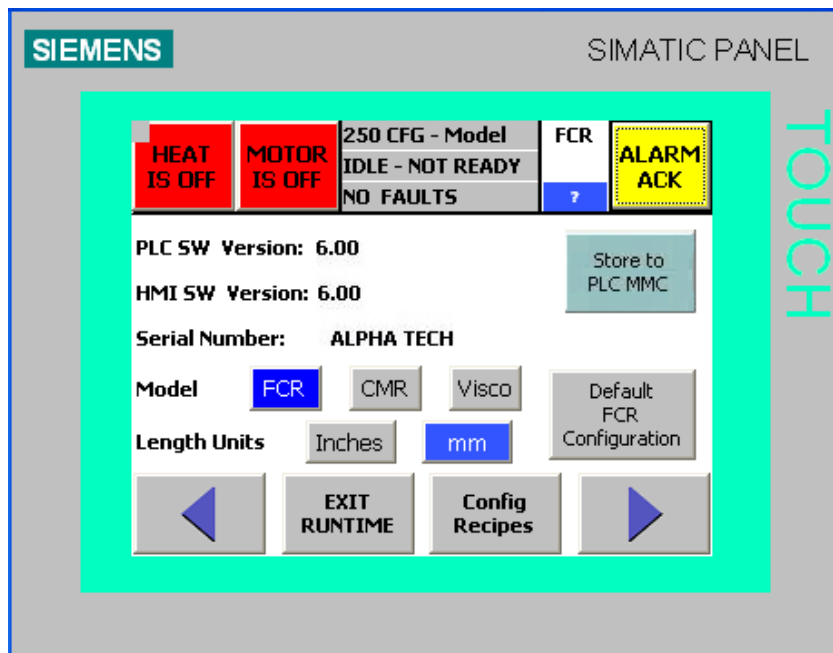

This screen should only be used if new software is loaded. All settings have already been configured at the factory.

The model FCR must be selected. Items that are selected or enabled are shown in blue.

The units of length are used when entering the capillary die diameter.

The Default Values button will set all setpoints and equation constants to default values.

The Default FCR configuration button will configure the default RTDs, pressure transducers, and 4-20 mA inputs and outputs for the FCR.

EXIT RUNTIME is pressed to access the operating system on the HMI. EXIT runtime on the HMI to calibrate the touchpad, adjust the display contrast, or to load new HMI software.

Config Recipes is pressed to access the Machine Configuration recipe screen for saving the instrument configuration to the HMI memory card.

The Store to MMC button saves all configuration and setup parameters to the CPU MMC. This permits all parameters to be restored when the MRES procedure is done.

NOTE: It is recommended to use Store to MMC any time a change is made to the FCR settings, otherwise, if the MRES procedure is done, any un-stored settings will require re-entry manually.

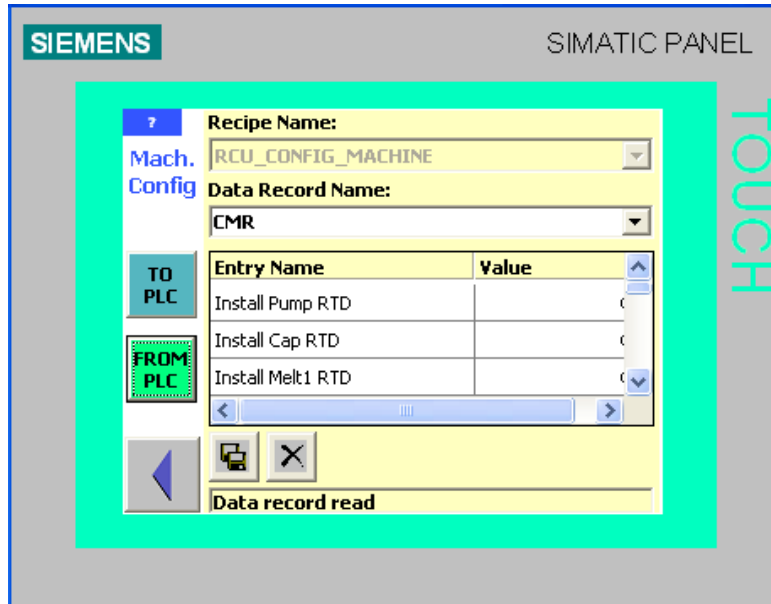

Data Record Name - Used to add a new configuration or recall a previously saved configuration files  
Entry Name – List of stored values within a configuration, this list is inclusive of all possible configuration parameters

**TO PLC** - Sends the currently viewed machine configuration to the PLC

**FROM PLC** - Reads configuration stored in the PLC into the current machine configuration on the HMI

NOTE: after reading from the PLC, in order to activate the just read values, the configuration screen must be exited and re-entered

- Saves the current configuration in a file, the file name will be prompted for and if a file of that name exists, a prompt will ask if it is to be overwritten

- Permanently removes a stored configuration file, a prompt will ask if the action is to be performed

Screen 251 shows the standard configuration for the RTDs on an FCR

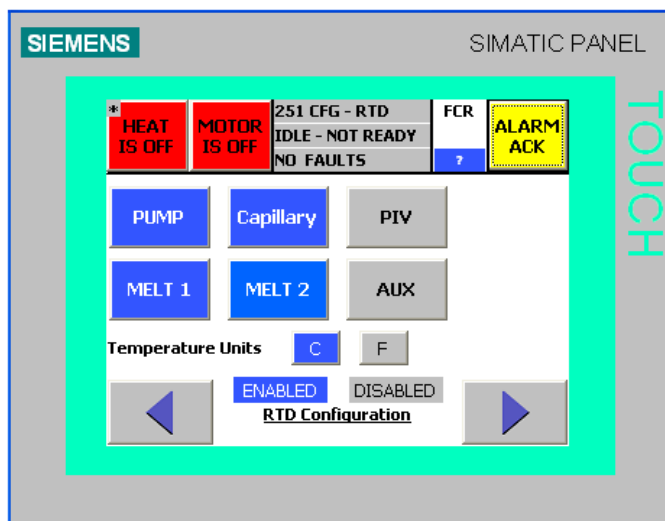

Temperature units can be displayed in either C or F. Press the button to select the desired units. If an optional AUX heater and RTD are installed, AUX needs enabled here. Press the AUX button to enable the AUX heater and RTD.

Screen 252 shows the standard configuration for the pressure transducers on an FCR.

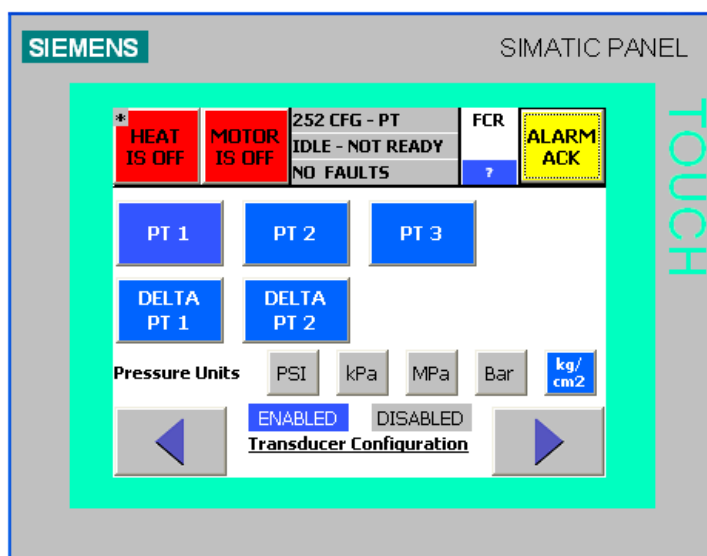

Pressure units can be displayed in either PSI, kPa, Mpa, Bar, or kg/cm<sup>2</sup>.

Screen 253 shows the standard configuration for communications on an FCR. Modbus, Ethernet, and Profibus DP-DP are communications options. The RS-232 ASCII output communication module is standard. The RS-232 (ASCII) output is factory set at 9600 baud, no parity, 8 data bits, 1 stop bit, and no flow control (9600:N:8:1).

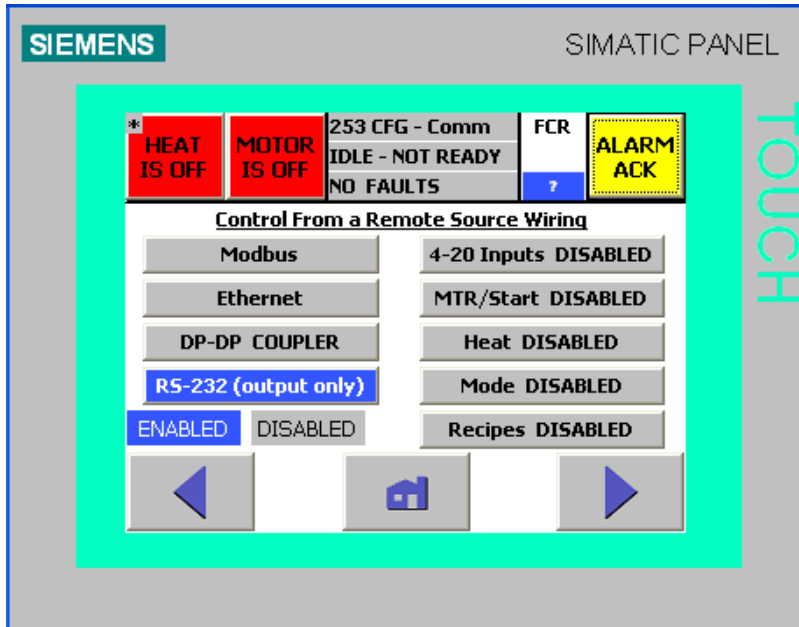

4-20 Inputs DISABLED/ENABLED – DISABLED: analog inputs are ignored with remote on and with remote off; ENABLED: inputs are read every second by the PLC when the remote is ON. The input is converted to the input selected in screen 255 and scaled in screen 241.

Heat DISABLED/ENABLED – DISABLED: discrete heat enable input is ignored with remote on and with remote off; ENABLED: discrete heat enable input is read every second by the PLC when the remote is ON

Motor DISABLED/ENABLED – DISABLED: discrete motor enable input is ignored with remote on and with remote off; ENABLED: discrete motor enable input is read every second by the PLC when the remote is ON

Mode DISABLED/ENABLED – DISABLED: discrete mode (speed/pressure) input is ignored with remote on and with remote off; ENABLED: discrete mode (speed/pressure) input is read every second by the PLC when the remote is ON



Screen 254 shows optional accessories that have been installed at the factory.

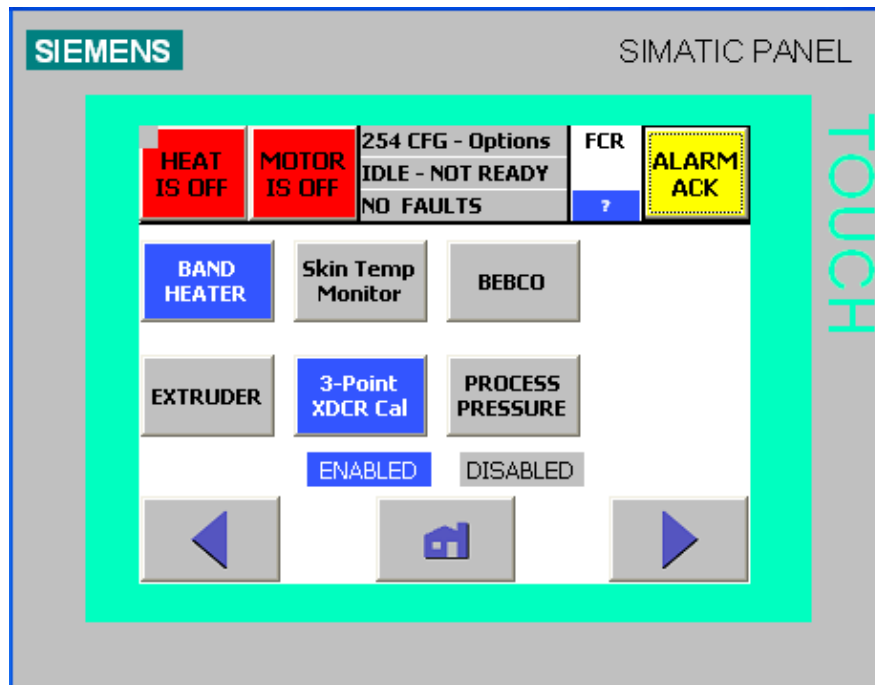

**BAND/CAST HEATER – BAND:** Adjusts the PID heat constants for a non-hazardous band heater  
**CAST:** Adjusts the PID heat constants for a hazardous area cast heater

**Skin Temp Monitor – ENABLED:** Temperature monitors are wired into the system such that a skin temperature exceeding the area temperature limit causes a rheometer fault. A skin over temperature fault activates the fault relay and disables the rheometer heat.

**BEBCO – ENABLED:** An input signal is required to enable the heaters

**EXTRUDER – ENABLED:** A Dynisco REX system is connected to the rheometer

**3-Point XDCR Cal – DISABLED:** Screens 220-222 Press Cal are used for pressure calibration, A 2-point pressure calibration curve is used to determine the pressure; **ENABLED:** Screens 230-232 Press Cal are used for pressure calibration, A 2-point or 3-point pressure calibration curve can be used to determine the pressure

**PROCESS PRESSURE – ENABLED:** A pressure transducer is attached to the PIV to monitor the input pressure to the rheometer. Low and high pressure limits can be set to activate warnings and faults.

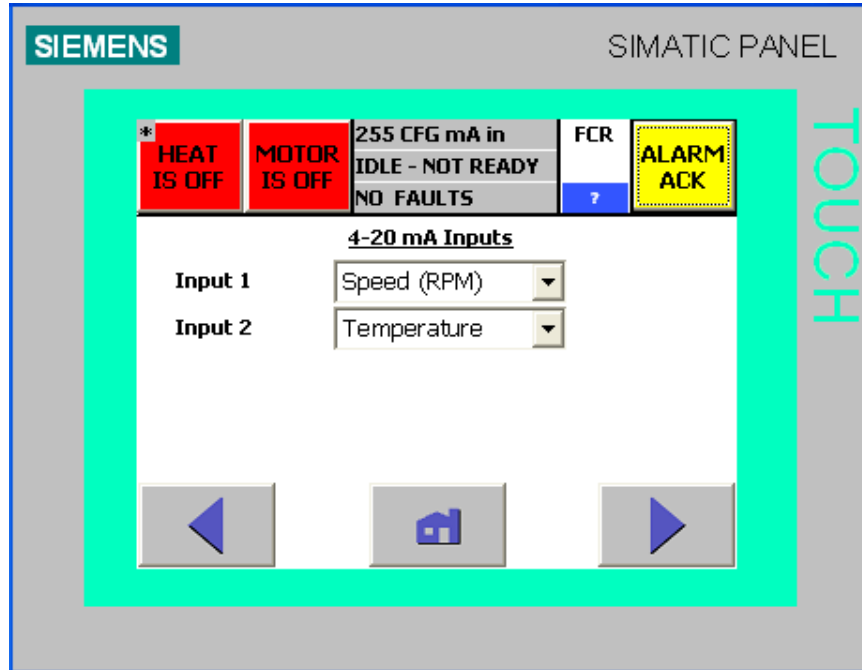

Configure the 4-20 mA inputs to set a process setpoint value. The parameter selected for Input 1 (2) is received by the rheometer on connection AI-1 (2) in the field wiring diagram. Select the parameter in this screen (255) and scale and calibrate the input in the Analog I/O Calibration screen 241.

The 4-20 mA input can be used to set the following setpoints:

- Pump temperature
- Capillary temperature
- Aux temperature
- Speed
- Pressure

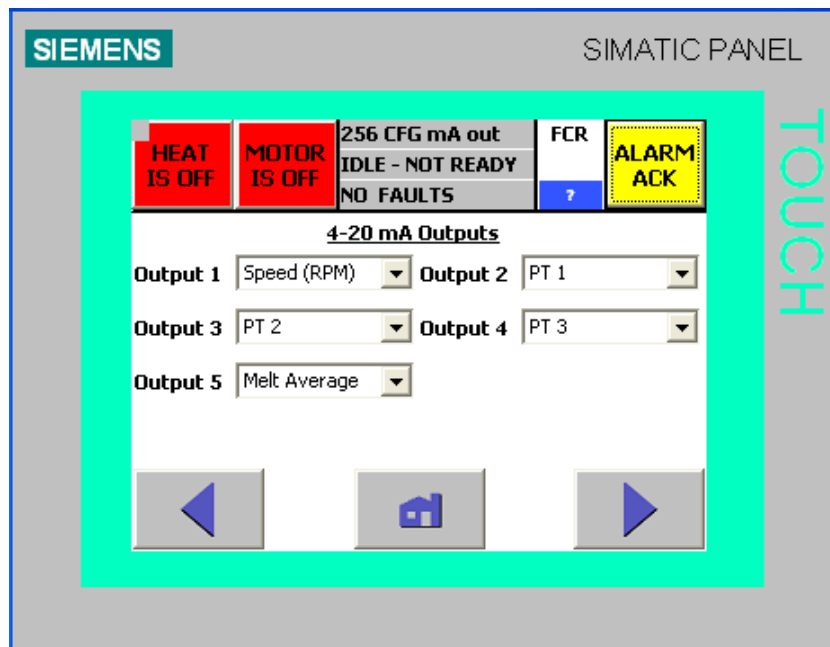

Configure the 4-20 mA outputs on the rheometer by selecting the desired parameters in this screen (316). The parameter selected for Output 1 (2/3/4/5) is transmitted by the rheometer on connection AO-1 (2/3/4/5) in the field wiring diagram. Scale and calibrate the outputs in the Analog I/O Calibration screens 242-245.

The 4-20 mA output can be selected from the following choices:

- Pump temperature
- Capillary temperature
- Melt 1 temperature
- Melt 2 temperature
- Melt temperature average
- Aux temperature
- Speed
- Pressure transducer 1 pressure
- Pressure transducer 2 pressure
- Pressure transducer 3 pressure
- Delta pressure 1
- Delta pressure 2
- MFR (capillary 1 or capillary 2)
- Shear rate (capillary 1 or capillary 2)
- Shear stress (capillary 1 or capillary 2)
- Melt viscosity (capillary 1 or capillary 2)
- Relative viscosity (capillary 1 or capillary 2)
- Intrinsic viscosity (capillary 1 or capillary 2)

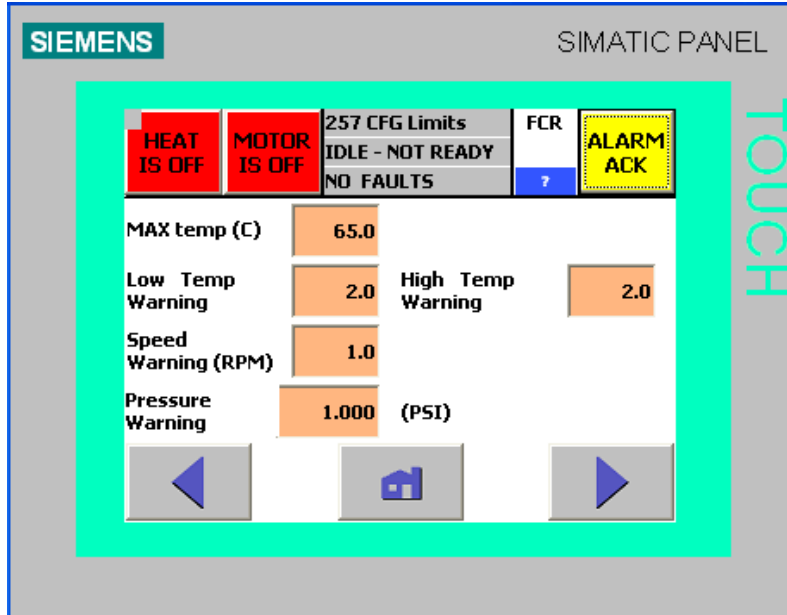

MAX temp - Maximum allowable temperature of the instrument. When any of the RTD readings reach this temperature, the heat is disabled and the fault relay is opened.

Low Temp Warning - A yellow warning message is displayed when a temperature reading deviates this many degrees below the setpoint.

High Temp Warning - A yellow warning message is displayed when a temperature reading deviates this many degrees above the setpoint.

Speed Warning - In speed mode, a yellow warning message is displayed when the actual speed deviates this many RPM above/below the setpoint.

Pressure Warning - In pressure mode, a yellow warning message is displayed when the actual pressure deviates this many units above/below the setpoint.

The warning relay is closed when no warnings are present. The warning relay is open when power is OFF or a warning exists. Warnings do not need to be acknowledged.

The fault relay is closed when no faults are present. The fault relay is open when power is OFF or a fault exists. Faults need to be acknowledged and are logged in the error log.

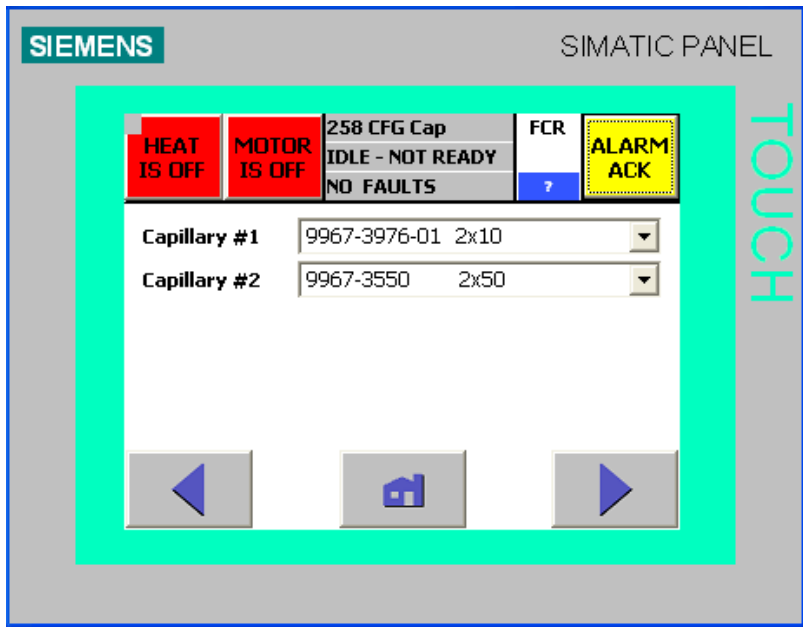

Screen 258 is used to enter the capillary selections that will be used on screen 120 for calculation constants. Screens 259, 25A, 25B and 25C are used for setting the PID Control loop constants. These constants have been factory set and should only be changed by trained personnel.

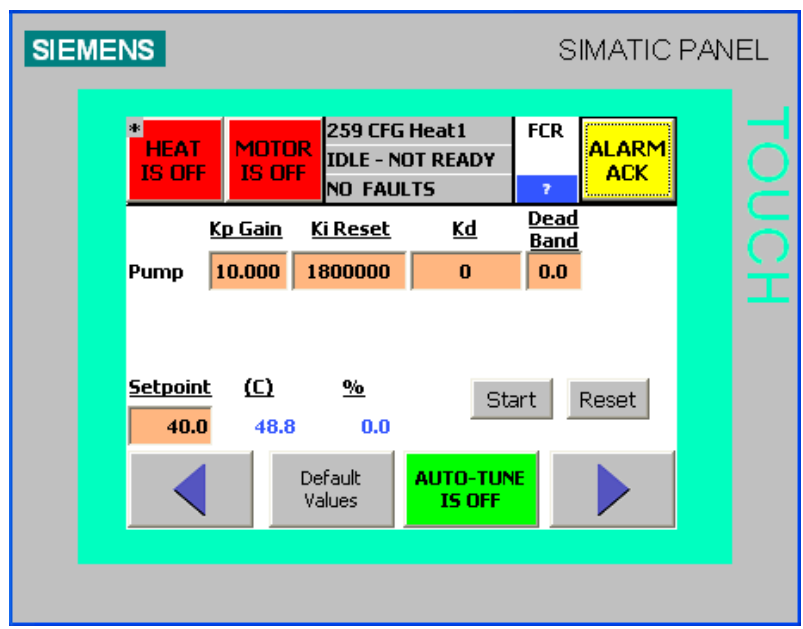



**SIEMENS** SIMATIC PANEL

**TOUCH**

<b>HEAT IS OFF</b>	<b>MOTOR IS OFF</b>	25A CFG Heat2 IDLE - NOT READY NO FAULTS	FCR ?	<b>ALARM ACK</b>
		<b>Ki Reset</b>	<b>Kd</b>	<b>Dead Band</b>
CAP	10.000	1800000	0	0.0
<b>Setpoint</b>	<b>(C)</b>	<b>%</b>		
40.0	45.6	0.0		
◀	Default Values	<b>AUTO-TUNE IS OFF</b>	▶	

**SIEMENS** SIMATIC PANEL

**TOUCH**

<b>HEAT IS OFF</b>	<b>MOTOR IS OFF</b>	25B CFG Heat3 IDLE - NOT READY NO FAULTS	FCR ?	<b>ALARM ACK</b>
		<b>Ki Reset</b>	<b>Kd</b>	<b>Dead Band</b>
AUX	10.000	1800000	0	0.0
<b>Setpoint</b>	<b>(C)</b>	<b>%</b>		
◀	Default Values	<b>AUTO-TUNE IS OFF</b>	▶	

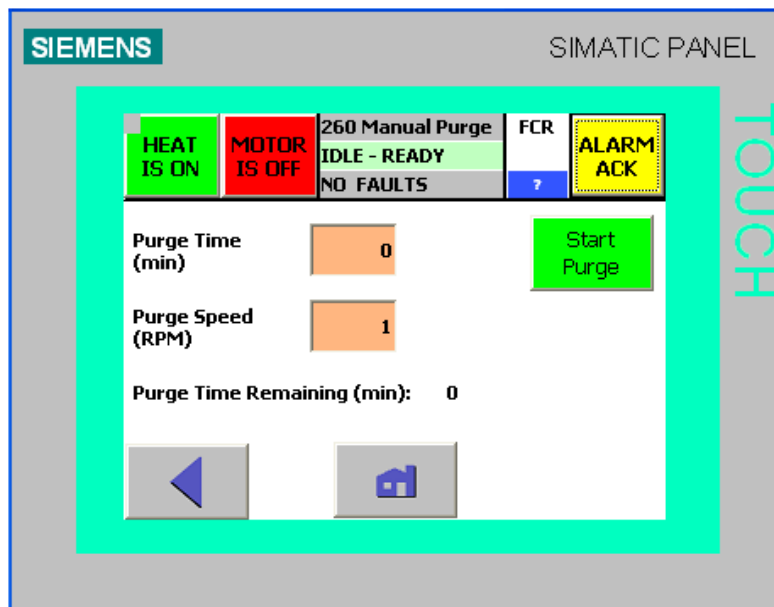
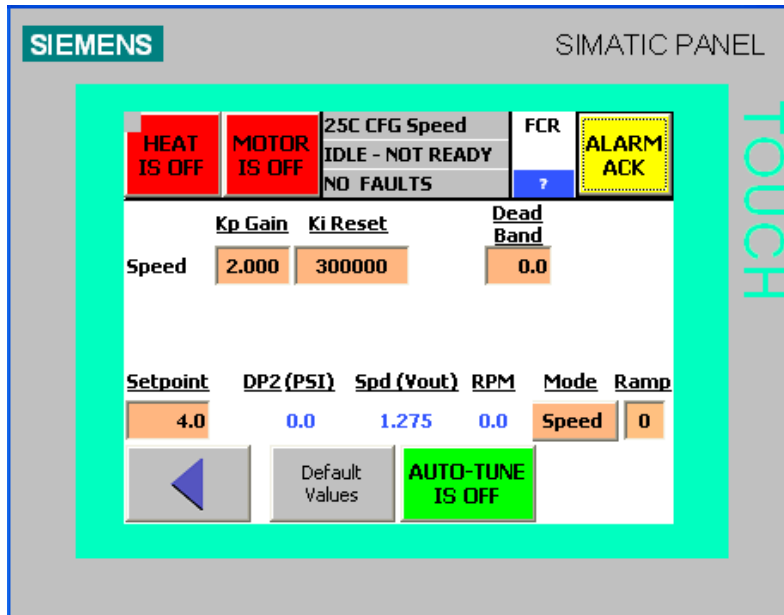

A manual purge is used to clear the rheometer of material. After the purge has completed, the rheometer heat is disabled.

Purge Time - range 0-1440 minutes,

Purge Speed - range minimum to maximum allowable speed (RPM)

Start Purge - button is visible when the rheometer state is IDLE-READY

Stop Purge - button is visible while purging, Press to interrupts the purge process.

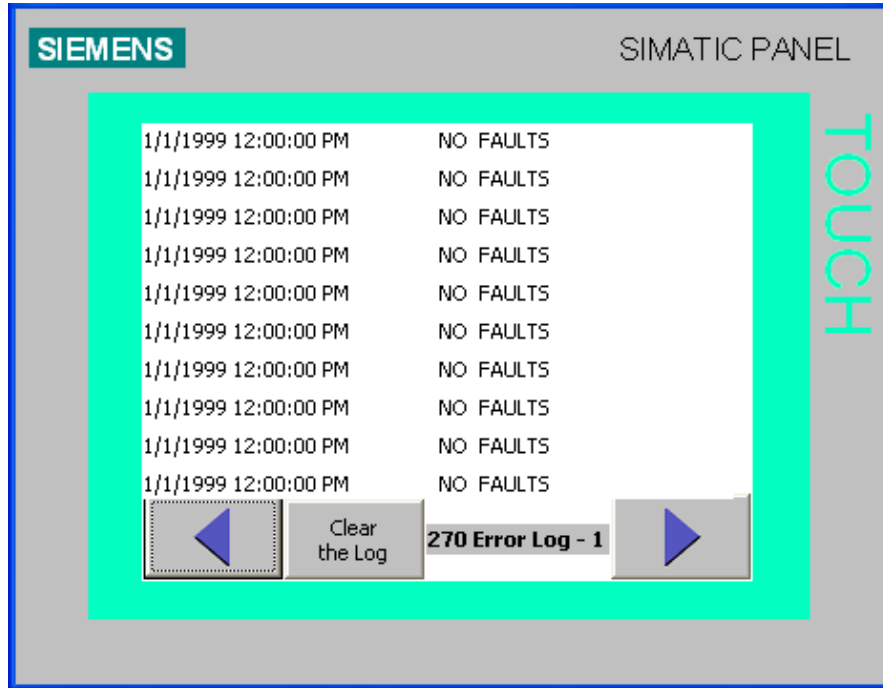

The most recent 25 faults are displayed on screens 270-272 Error Log. The most recent fault is displayed first. Faults are displayed along with the date and time of the occurrence. Clear the error log by pressing the Clear the Log button.

Diagnostics (340-348)

**CAUTION – ALL outputs are manually controlled in the DIAGNOSTICS screens! Normal operation is suspended when using the DIAGNOSTICS!**

**CAUTION – DO NOT ENABLE THE MOTOR WHILE IN THE DIAGNOSTICS UNLESS THE HEAT IS AT TEMPERATURE OR THE MOTOR IS DISCONNECTED FROM THE PUMP! THIS WILL DAMAGE THE PUMP!**

This Diagnostics screen shows the status of all the analog inputs.

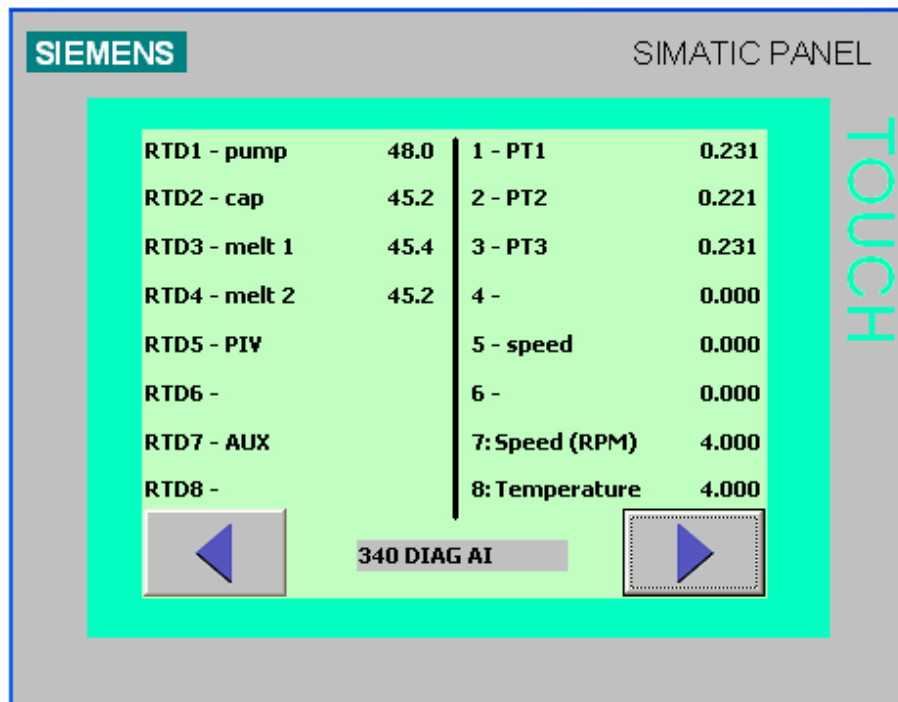

These two Diagnostic screens show the status of all the analog outputs. The analog output can be forced to the value shown in the button by pressing the button. Use these for troubleshooting 4-20 mA field wiring.

**SIEMENS** SIMATIC PANEL

**TOUCH**

Description	Value	ZERO	MIDDLE	MAX
1: MSC 0-10V	0.0	ZERO	5 V	10 V
2: Speed (RPM)	0.0	4 mA	12 mA	20 mA
3: PT 1	0.0	4 mA	12 mA	20 mA
4: PT 2	0.0	4 mA	12 mA	20 mA

341 DIAG AO 1

**SIEMENS** SIMATIC PANEL

**TOUCH**

Description	Value	ZERO	MIDDLE	MAX
5: PT 3	0.0	4 mA	12 mA	20 mA
6: Melt Average	0.0	4 mA	12 mA	20 mA

342 DIAG AO 2



This Diagnostic screen shows the status of all the digital inputs.

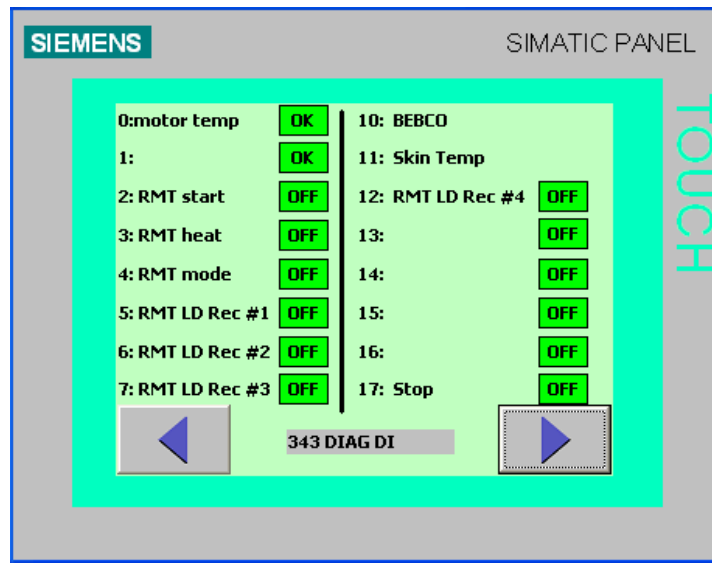

Screens 264-267 show the status of all the digital outputs. Press the OFF button to force the output OFF. Press the ON button to force the output ON.

**CAUTION – DO NOT ENABLE THE MOTOR WHILE IN THE DIAGNOSTICS UNLESS THE HEAT IS AT TEMPERATURE OR THE MOTOR IS DISCONNECTED FROM THE PUMP! THIS WILL DAMAGE THE PUMP!**

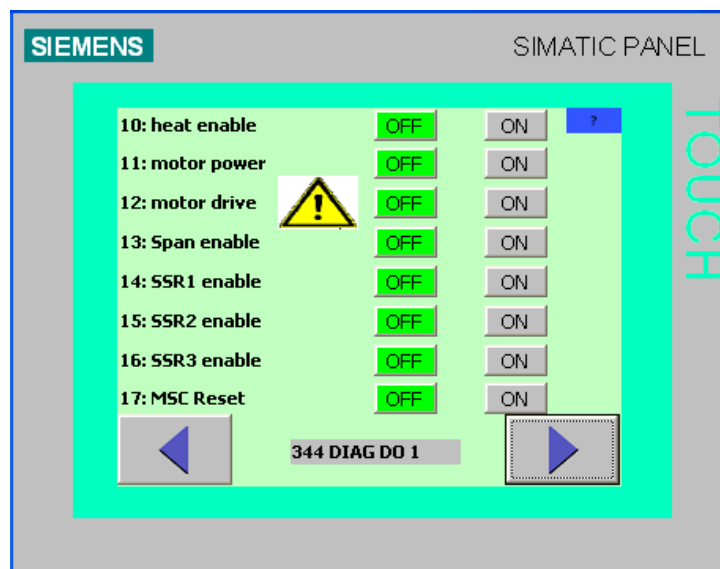

**SIEMENS** SIMATIC PANEL

**TOUCH**

20:	<input type="button" value="OFF"/>	<input type="button" value="ON"/>
21:	<input type="button" value="OFF"/>	<input type="button" value="ON"/>
22:	<input type="button" value="OFF"/>	<input type="button" value="ON"/>
23:	<input type="button" value="OFF"/>	<input type="button" value="ON"/>
24: Recipe #1 active	<input type="button" value="OFF"/>	<input checked="" type="button" value="ON"/>
25: Recipe #2 active	<input type="button" value="OFF"/>	<input type="button" value="ON"/>
26: Recipe #3 active	<input type="button" value="OFF"/>	<input type="button" value="ON"/>
27: Recipe #4 active	<input type="button" value="OFF"/>	<input type="button" value="ON"/>

345 DIAG DO 2

**SIEMENS** SIMATIC PANEL

**TOUCH**

30: fault relay	<input type="button" value="OFF"/>	<input checked="" type="button" value="ON"/>
31: warning relay	<input type="button" value="OFF"/>	<input checked="" type="button" value="ON"/>
32: local/remote	<input type="button" value="OFF"/>	<input type="button" value="ON"/>
33: motor status	<input type="button" value="OFF"/>	<input type="button" value="ON"/>
34: Material in range	<input type="button" value="OFF"/>	<input type="button" value="ON"/>
35:	<input type="button" value="OFF"/>	<input type="button" value="ON"/>
36:	<input type="button" value="OFF"/>	<input type="button" value="ON"/>
37:	<input type="button" value="OFF"/>	<input type="button" value="ON"/>

346 DIAG DO 3

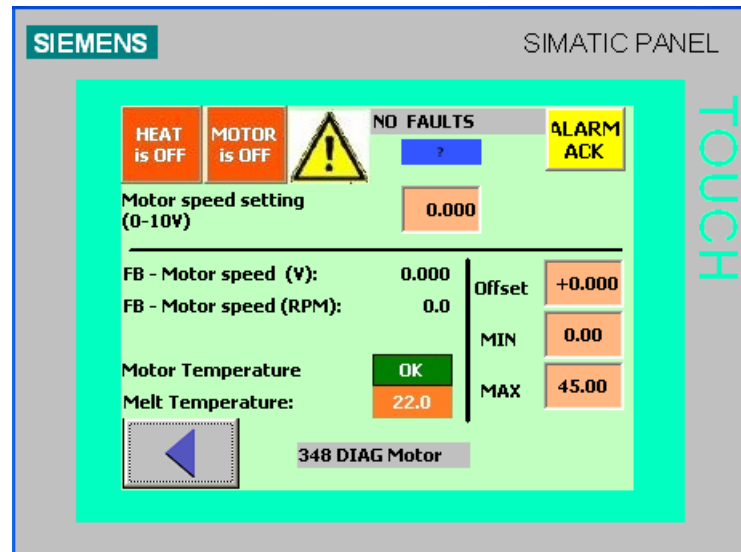
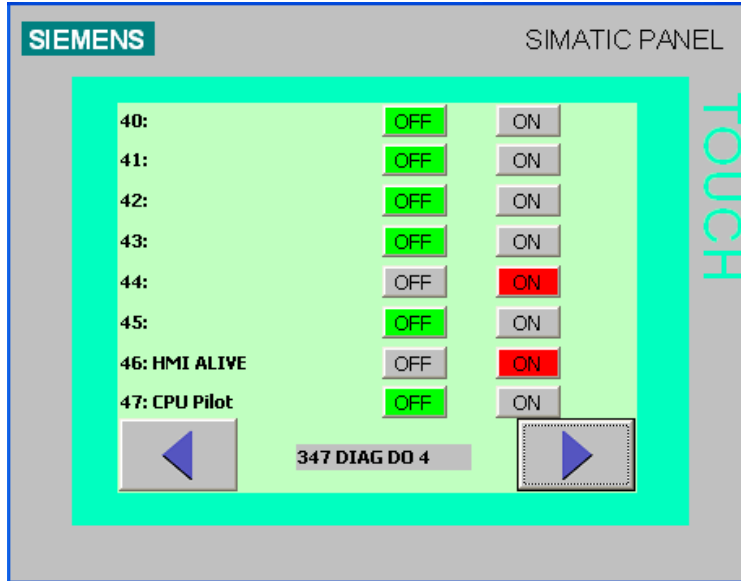

This screen is to be used by trained service personnel for calibrating the motor speed. Call the factory for assistance.

**IO Status (310)**

The status of inputs is shown in the left column

The status of outputs is shown in the middle and right columns.

The HMI alive and CPU alive outputs should cycle on and off about 1 time every second. These two outputs show that the HMI and the CPU/PLC are executing.

The temperature associated with the three heat zones is shown along with the percentage of time the output is on. The AUX zone will only be shown if the optional AUX RTD is installed.

**SIEMENS**
SIMATIC PANEL

INPUTS	OUTPUTS	OUTPUTS			
Motor OTemp	<input checked="" type="checkbox"/> ON	Motor Enable	<input type="checkbox"/> OFF	Heat Enable	<input type="checkbox"/> OFF
Rmt Mtr Ena	<input type="checkbox"/> OFF	Pump Status	<input type="checkbox"/> OFF	Heat SSR1	<input type="checkbox"/> OFF
Rmt Heat Ena	<input type="checkbox"/> OFF	Local/Remote	<input type="checkbox"/> OFF	Heat SSR2	<input type="checkbox"/> OFF
Rmt Mode	<input type="checkbox"/> OFF	Warning Relay	<input type="checkbox"/> OFF	Heat SSR3	<input type="checkbox"/> OFF
E-Stop	<input checked="" type="checkbox"/> OK	Fault Relay	<input type="checkbox"/> OFF	HMI ALIVE	<input type="checkbox"/> OFF
		Span Relay	<input type="checkbox"/> OFF	CPU ALIVE	<input type="checkbox"/> OFF
Speed (Vin)	0.000	<b>310 IO Status 1</b>	<b>(C)</b>	<b>%</b>	
Speed (Vout)	1.275	<b>Pump</b>	<b>47.1</b>	<b>0.0</b>	
		<b>Cap</b>	<b>44.7</b>	<b>0.0</b>	
		<b>Melt1</b>	<b>44.9</b>		

TOUCH

Machine Hours (330)

**SIEMENS**
SIMATIC PANEL

<b>HEAT IS OFF</b>	<b>MOTOR IS OFF</b>	<b>330 Machine Hours</b>	<b>FCR</b>	<b>ALARM ACK</b>
<b>IDLE - NOT READY</b>		<b>NO FAULTS</b>	?	
RHEOMETER				
<b>Running (Hours)</b>	0.2			
<b>Fault (Hours)</b>	2.6			
<b>IDLE-Ready (Hours)</b>	3.0			
<b>Standby (Hours)</b>	0.0			
<b>Shutdown (Hours)</b>	0.0			
<b>Lifetime (Hours)</b>	231.8			

TOUCH



- Running – number of hours the instrument has been in the RUN state
- Fault – number of hours the instrument has been in a fault condition.
- IDLE-Ready - number of hours the instrument has been in the IDLE-Ready state
- Standby - number of hours the instrument has been in the Standby state
- Lifetime - number of hours the instrument has been powered up

Setup IP Address (320) (if option supplied)

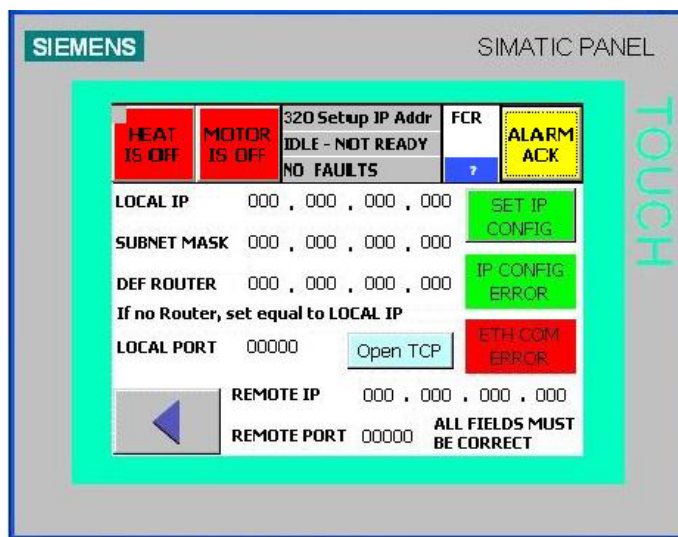

### Local Display System Operations

To change the local display’s setup parameters, the display’s CONTROL PANEL must be accessed. Access to the CONTROL PANEL is possible when power is applied to the display and by using the EXIT RUNTIME button on screen 310 in the Machine Configuration. When power is applied to the display, a short self-test is performed, next a menu screen with multiple buttons is visible for approximately 3 seconds. If none of the buttons are pressed, the display will automatically show the Start Up screen followed by the MAIN screen of the application software.

The four buttons on the menu are TRANSFER, START, CONTROL PANEL, and TASK BAR. When the CONTROL PANEL button is pressed, a WINDOWS type control panel should be seen. All the WINDOWS properties will apply. To exit the CONTROL PANEL, press the “X” in the upper right corner of the screen. The TRANSFER, START, and CONTROL PANEL menu should be seen. Press START, the application software MAIN screen should be seen after a few seconds.

### Display Contrast

From the display’s WINDOWS control panel, double tap the OP icon. Select the DISPLAY tab from the OP PROPERTIES screen. Use the UP and DOWN buttons to adjust the display contrast. Tap the OK button to return to the CONTROL PANEL.

### Touch Screen Calibration

If the display is not responding to the selected touch field, it may be necessary to recalibrate the touch panel. From the display’s WINDOWS control panel, double tap the OP icon. Select the TOUCH tab from the OP PROPERTIES screen. Follow the on-screen instructions. Tap the OK button to return to the CONTROL PANEL





### Resetting Display Systems Data

A copy of the display's operating systems data is stored on a memory card located on a rear side panel of the display. It may be necessary to restore the operating system data if,

1. New display software is needed.
2. The operation of the display is erratic.

To restore the operating systems data,

1. Press the EXIT RUNTIME pushbutton on the Machine Configuration screen. The four-button menu, TRANSFER, START, and CONTROL PANEL, and TASK BAR should be seen.
2. Press the CONTROL PANEL pushbutton. A Windows type control panel should be seen. All the Windows properties will apply.
3. Press the BACKUP/RESTORE icon. Follow the RESTORE on-screen instructions.
4. To exit the CONTROL PANEL, press the "X" in the upper right corner of the screen. The TRANSFER, START, and CONTROL PANEL menu should be seen.
5. Press START, the application software MAIN screen should be seen after a few seconds.



## V. Rheometer Technical Manual

The rheometer is the “sensing end” of the system. It is connected to the polymer melt to be tested through the transfer line and is driven by the RCU. The rheometer receives the polymer melt, pumps it through the capillary orifices, and measures the flow rate and pressure drop across the capillaries. With these measurements the shear-rate/shear-stress relationship of a polymer can be determined and converted into such standard items as Melt Flow Index or Apparent Viscosity. After analysis, the test polymer is pumped back into the process.

### GENERAL OPERATION

#### Pressure Measurement System

The pressure transducers located in the measurement head convert the cavity pressure to an electrical signal. The transducers are unbonded strain gauge (2 active arm bridge) which makes direct contact with the polymer. Changes in cavity pressure produce stress changes in the transducer bridge resistance which results in an electrical signal proportional to the pressure. The transducers are mounted deep within the capillary end of the flow passage barrel, just above the capillaries, and are specially designed to withstand the high test temperatures. Refer to the RCU Technical manual section for a further discussion of this function.

#### Speed Measurement System

The metering pump, pump motor and tachometer are directly coupled together. The tachometer signal is calibrated to read out pump speed. The 2400 Hz. Tachometer signal is fed into a frequency to voltage converter. The 0-10 VDC analog voltage is fed to the PLC. The voltage is scaled by the PLC to produce the pump shaft speed in RPM. Refer to the RCU Technical manual section for a further discussion of this function.

#### Motor Speed Control System

The motor speed control is a closed loop system. The required shear rate is developed by controlling the pump speed. The pump speed is sensed by the digital tachometer located in front of the motor. The tachometer signal is a digital pulse train. In the normal operate mode, the remote control unit speed PID loop compares the speed signal with the loop set point signal and a motor speed control signal (0-10VDC) is sent to the motor speed controller to drive the DC motor. There is an acceleration circuit in the motor speed controller to protect the pressure transducer on start-up. The motor speed controller converts the high-level controller signal to a full wave phase controlled DC signal to drive the motor. The MSC has a MAX and MIN adjustments. Refer to the RCU manual calibration section for a further discussion of this function.

#### Temperature Control System

The temperature control system maintains the polymer melt at the precise test temperature. In the flow passage barrel (measurement head), the melt temperature is regulated by two zones of closed loop temperature control (with polymer residence time, thermal mass and proper insulation). The first control zone is around the metering pump, and largely accounts for differences between polymer feed and test temperatures. The second temperature control zone regulates temperature around the test zone itself (capillary-transducer area). The process temperature is read by a grade “A” 3-wire RTD. Refer to the RCU Technical manual section for a further discussion of this function.



### MAINTENANCE

Maintenance is generally limited to changing and cleaning capillaries. Covers must be removed for access to pump and transducer.

#### Anti-Seize Compound

When replacing components that are connected to the flow passage barrel, a "high-temperature anti-seize" compound should be used on all threads.

#### Insulation

Good flow measurements are directly related to good insulation practices because of the temperature sensitivity of polymer viscosity. Any part of the polymer flow system (polymer tap, transfer line, and measurement head) should have good temperature control and proper insulation. These parts should also be protected from water and large air currents (especially the exposed bottom of the capillary). Within the measurement head, general insulation practice is to pack the capillary zone (lower section) heavily and the pump zone (upper section) lightly with a half thickness of insulation. If the insulation becomes oil soaked during transducer calibration, it should be replaced.



## Capillary Removal / Replacement

Capillaries are accessed from the top of the unit and should only be removed when the Rheometer is stopped. Use anti-seize compound on the screws each time, however do not let the compound build up. The following procedure is recommended:

### Removing the Capillary

1. Rheometer must have the pump motor stopped. Close the inlet and outlet valves.

**NOTICE** - the capillary inserts and their location in the flow passage block are labeled (1 or 2). DO NOT REVERSE THE CAPILLARY INSERTS With the break-over and socket on the capillary jam nut, hit the handle sharply to loosen

2. Remove the two screws holding the capillary insert. Insert one of the screws into the threaded hole located on the capillary insert. Slowly turn this screw clock-wise. The capillary insert should start to move out of the flow passage block. Slowly remove the capillary insert from the flow passage block.

**WARNING** - the capillary and retainers may fall from the insert (see figure 1).

3. Clean the capillary using a soft cloth. Capillaries can also be cleaned with a solvent if necessary.  
4. Inspect and replace all o-rings as necessary

**CAUTION: DO NOT DAMAGE THE SEALING SURFACE ON THE ORIFICE**

**CAUTION: DO NOT TOUCH TRANSDUCER FACE**

### Installing the Capillary

1. Reassemble the capillary insert, retainers, and capillary as shown in figure V-1.

2. Slowly push the assembly into the flow passage block.

**WARNING** - it is possible to over pressurize the pressure transducers. If necessary, remove some test fluid from the capillary area.

3. When the insert is seated in the flow passage block, tighten the mounting screws.

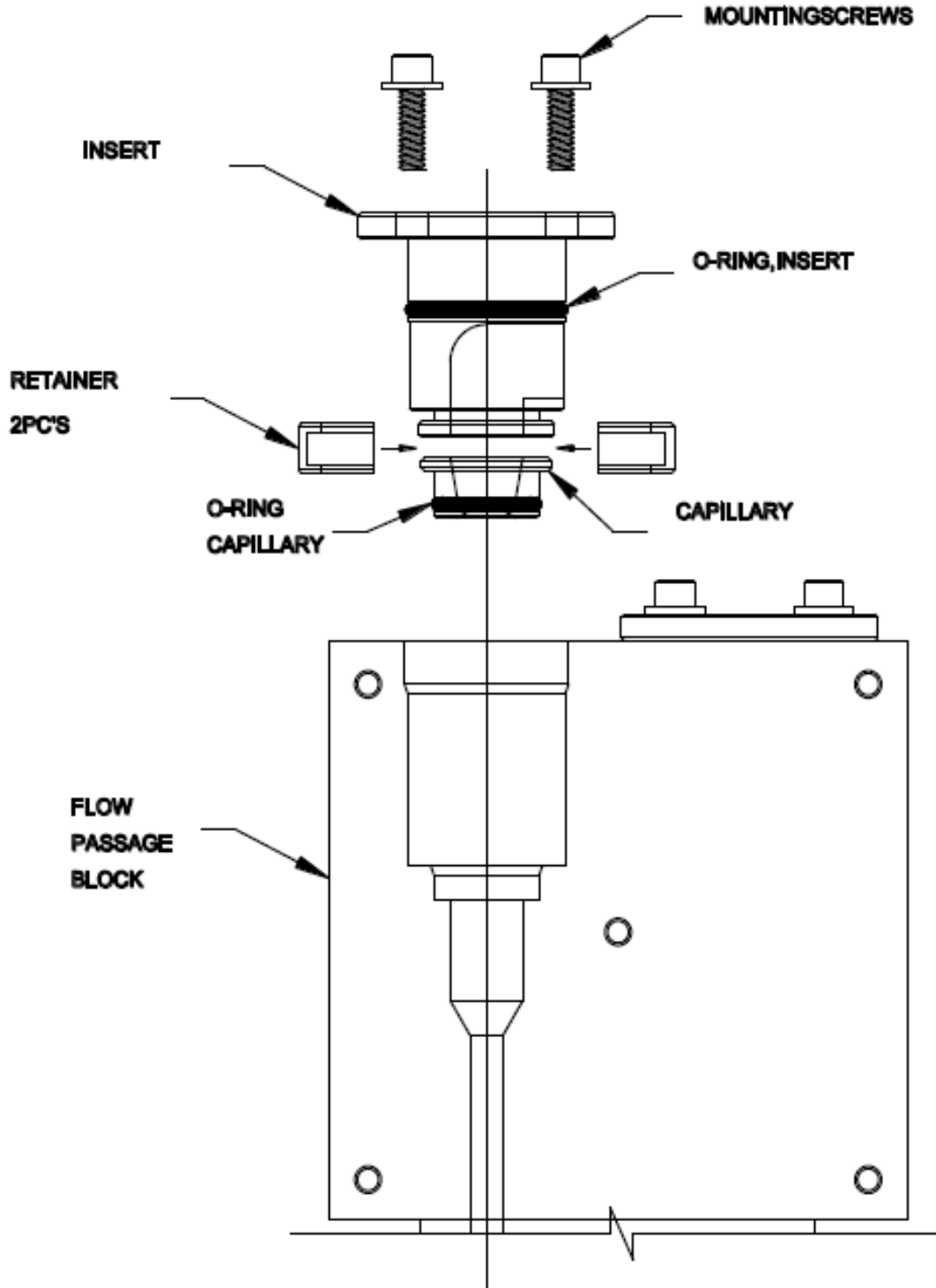

**FIGURE V-1 CAPILLARY ASSEMBLY**



## Metering Pump Replacement

The pump must be removed when hot. The protective covers must be removed for access. The following procedure is recommended:

### Pump Removal

1. Rheometer must be at test temperature.
2. Rheometer motor must be stopped.
3. Close the inlet and outlet valves.
4. Loosen the set screws on the gear reducer /pump coupling and open coupling
5. Remove the center section of the coupling. Note: Do not lose.
6. Loosen the four pump mounting screws and slide the pump out. Note: If there is any doubt about the pump drive pin (shear pin), it can be checked while hot. Clean the pump passages and, while looking into the passages, turn the pump by hand and see if the gears turn.
7. Clean the pump seating surface on the flow passage block with a soft copper cloth or, if necessary, a soft copper putty knife.

Note: See manufacturer’s manual for pump disassembly instructions.

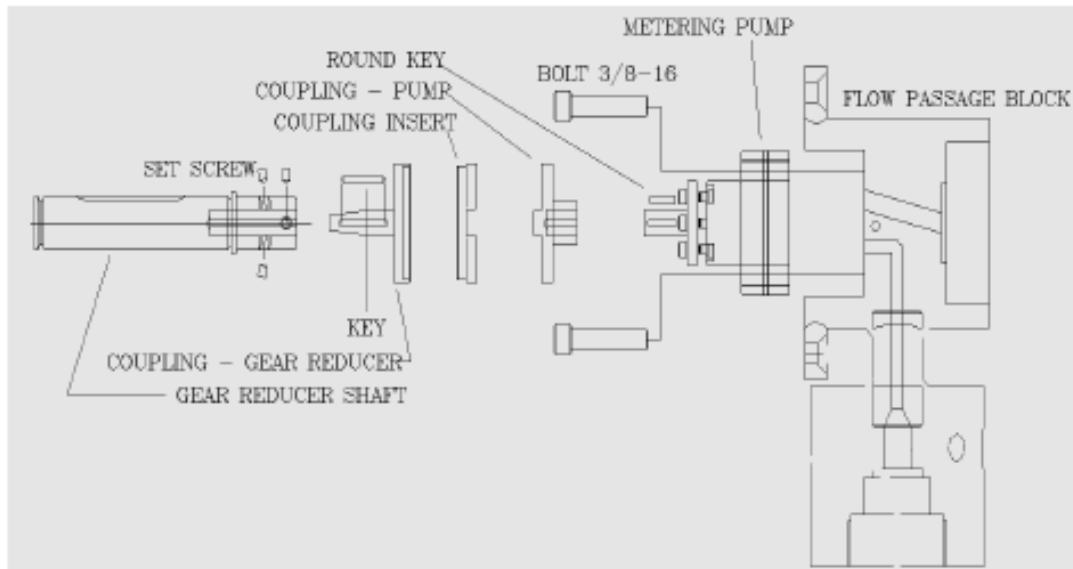

**FIGURE V-2 - EXPLODED VIEW METER PUMP and DRIVE SHAFT**

### Pump Installation

1. Reverse removal procedure to install pump using anti-seize compound on the screw threads. Note: snug the pump screws up so that the pump can move, and repositioned the coupling. Run the motor and let the pump align itself before tightening bolts.
2. Tighten bolts after pump has had time to heat.
3. Check the pump for leaks during operation.
4. Ensure that the pump coupling is aligned as shown. If alignment is required, make adjustments to the flow block mounting bolts and/or the block stabilizer arms.

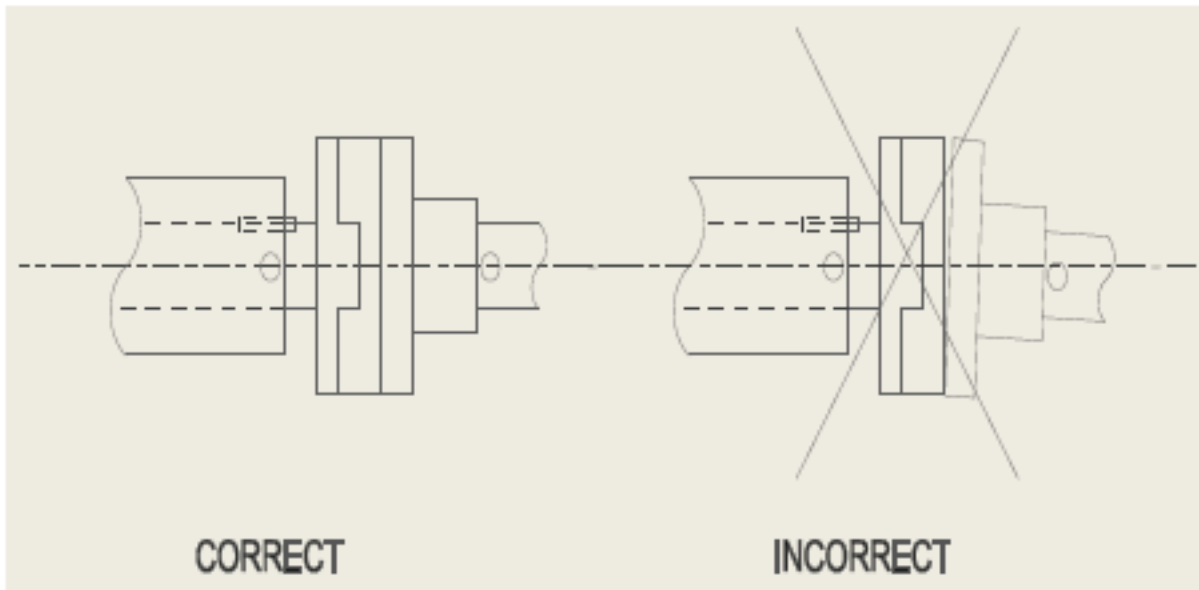

**FIGURE V-3 PUMP COUPLING ALIGNMENT**



## Transducer Replacement

Transducers must be replaced while the Measurement Head is hot. After a transducer is removed, clean and check the transducer seat (use a soft cloth). The following procedure is recommended:

### Transducer Removal

1. Rheometer must be at test temperature.
2. Rheometer motor must be stopped.
3. Close the inlet and outlet valves.
4. Disconnect the transducer cable.
5. Unscrew the transducer.
6. Clean the transducer seat with a soft cloth and wipe the anti-seize out of the threads.

### Transducer Installation

1. Check that the new transducer is the correct range
2. With anti-seize on threads, screw the transducer into the flow passage block.
3. Let the transducer heat for 5 minutes.
4. Tighten gently (100 in-lbs max.).
5. Connect the transducer cable.
6. Run fresh polymer through the system
7. Let the transducer stabilize at test temperature.
8. Calibrate the pressure transducer. (See Calibration section of this manual)

### Tachometer Replacement

The tachometer is a magnetically coupled detector that counts the teeth on a gear as it passes by the face of the tachometer. It should be positioned as follows:

WARNING: Do not place tools or fingers in tachometer hole

1. Allow the unit to heat to test temperature
2. Go to screen 268 DIAG Motor
3. Enable the heat.
4. Set the motor voltage to .25 VDC and enable the motor.
5. Screw the tachometer, with only one lock nut, into the tach ring until approximately 90% of the threads are in the ring. Connect signal cable.
6. Align the small flats on the tachometer body to the gear that is located in the tach ring as shown in Figure V-4.
7. Check the HMI for a speed indication (about 1 RPM).
8. If there is not a speed indication, screw the tachometer another  $\frac{1}{2}$  revolution into the tach ring.
9. Repeat the previous two steps until a speed indication is seen on the HMI.
10. Tighten the tach lock nut such that the tachometer cannot rotate.

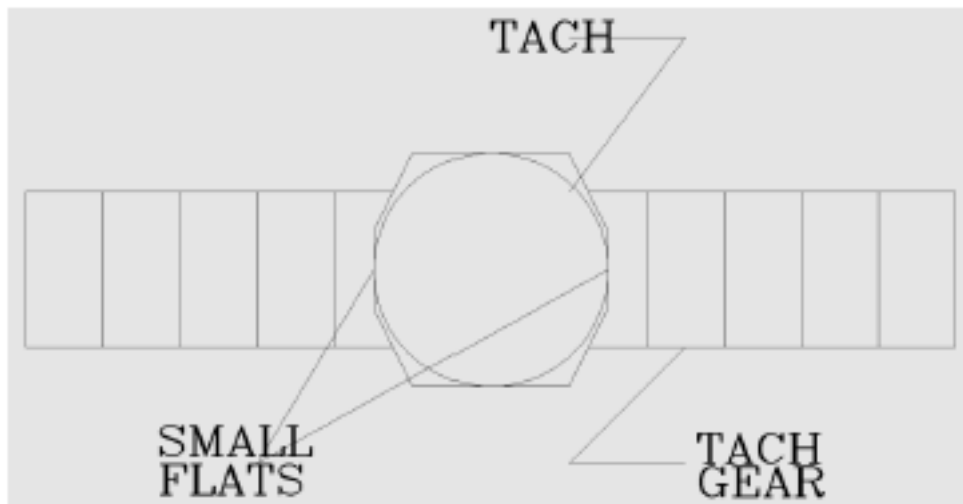
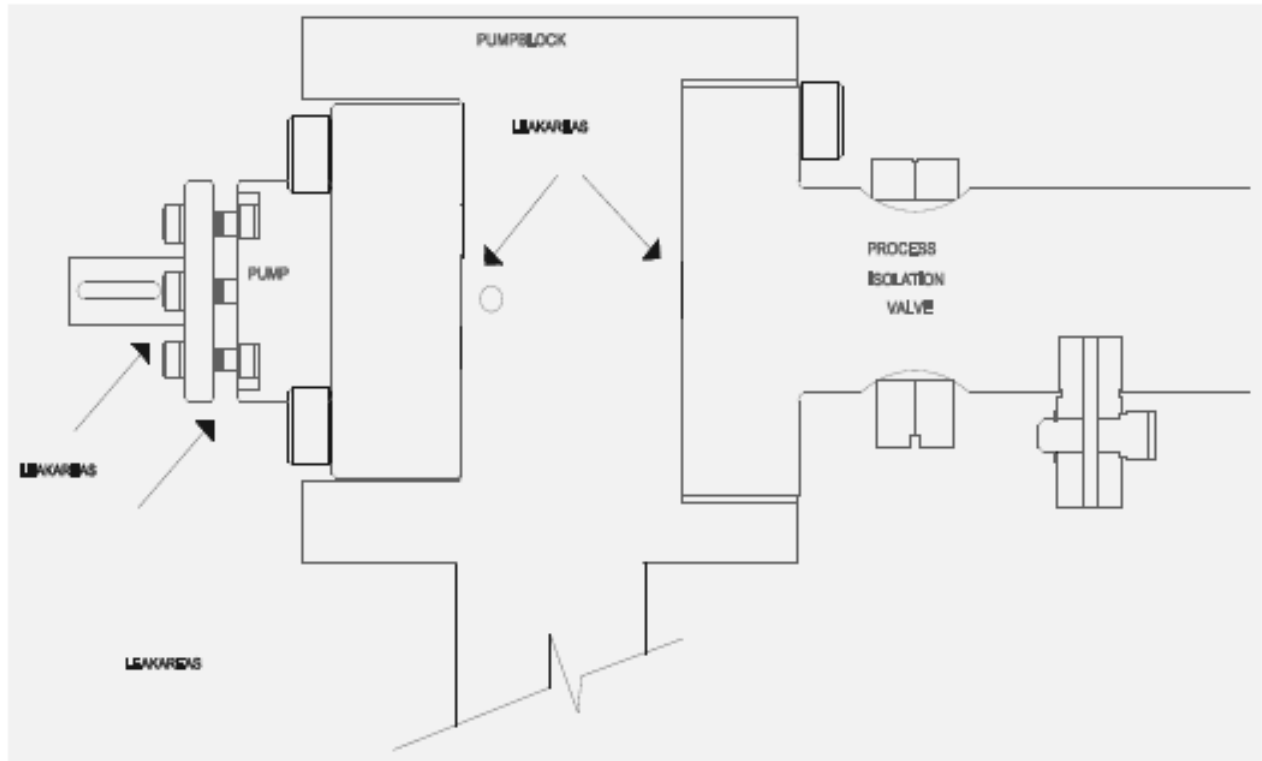

FIGURE V-4 TACHOMETER INSTALLATION



**FIGURE V-5 LOCATION OF POSSIBLE POLYMER LEAKS**

### Flow Block Leak Inspection

It is recommended that the flow block be inspected for polymer leaks every week. This will allow the maintenance technician to correct small leaks before the block is encapsulated in polymer. The following figure shows the common areas where leaks occur.

To stop the leaks, tighten the affected cap head socket screws. If the leak continues, it will be necessary to remove the part and clean the sealing surface. The metering pump is designed to "weep" polymer. This small amount of polymer is used to lubricate the bearing surfaces. The small weepage should flake off of the drive shaft and not cause a problem. If the polymer weepage is sufficient enough to flow a ball of polymer or fails to flake off of the drive shaft, tighten the three pump packing gland screw.

### WARNING

Tighten pump packing gland screws in small increments to avoid damage to the pump and pump drive system.





## TROUBLESHOOTING

### Polymer Flow Problems

#### PUMP MOTOR WILL NOT TURN

- 1) Abnormal alarm condition – clear alarms.
- 2) Motor drive or motor failure. Repair – replace motor speed controller

#### PUMP MOTOR TURNS BUT NO POLYMER FLOW FROM CAPILLARY

- 1) PIV shut off valve closed – open valve
- 2) No flow in sample line – open the bleed valve and check for polymer in sample line.
- 3) Broken shear pin in metering pump – replace / repair pump.
- 4) Pump coupling failure – replace / repair pump coupling.

#### OVER SPEED ALARM IN MFI MODE

- 1) Pump is starving for material at high speeds or high viscosity (low MFI)
- 2) Transducer failure – test / replace transducer.
- 3) Pump starvation – install proper range capillary

#### Unstable Measurement

- 1) Large variations in process temperatures.
- 2) Large variations in flow block temperatures.
- 3) Pump loading – alignment or dragging.

#### Large Measurement Error

- 1) Incorrect control setpoints or test parameters
- 2) Incorrect capillary installed
- 3) Transducer calibration - bad low end sensitivity.
- 4) Fluid leaks
- 5) Pump speed deviation

#### VI. Calibration

In the Rheology Measurement System, there are three components requiring calibration: the pressure transducers, the temperature sensors, and the Motor Speed Controller.



## EQUIPMENT REQUIRED TO CALIBRATE SYSTEM

There are two pieces of equipment required for calibration of the rheometer. The first is a dead weight tester that has sufficient range to cover the pressure of interest. The second is a device to test the temperature indication electronics. A controlled temperature bath tests the probe and the electronics. A temperature probe simulator tests the electronics only. Contact DYNISCO for the manufacture information for each of these devices. Trouble shooting routines will isolate to component level require only a multimeter.

## PRESSURE TRANSDUCER CALIBRATION

The software located in the CPU converts the raw millivolt signal from the pressure transducer into engineering units (PSI). During the pressure transducer calibration routines, the raw millivolts for pre-programmed pressures are stored in the CPU. Using the stored millivolts, the CPU generates a line that connects the calibrations points. Each transducer is calibrated individually. In the software, there are three transducer curves. These are (1) default, (2) auto-cal, and (3) manual-cal. These curves are shown in figure VI-1. The “default” curve passes through 0 PSI/0 mV and the theoretical 100% of pressure and millivolts. This curve is used after a Factory default setting. The simplified equation is shown below:

$$P_{\text{Reading}} = \frac{E_{\text{Meas}}}{E_{\text{FS}}} * P_{\text{FS}}$$

NOTE: The following terms will apply to all pressure formulas found in this section.

P<sub>Reading</sub> – indicated pressure transducer output in PSI.

E<sub>meas</sub> – pressure transducer output in millivolts.

E<sub>0</sub> – recorded pressure transducer output at atmosphere in millivolts.

E<sub>1</sub> – recorded pressure transducer output at cal point 1 in millivolts.

E<sub>2</sub> – recorded pressure transducer output at cal point 2 in millivolts.

E<sub>R-Cal</sub> - recorded pressure transducer output at R-Cal in millivolts.

E<sub>FS</sub> – pressure transducer theoretical output at full-scale (33.33mVDC).

P<sub>0</sub> – pressure 0 PSI

P<sub>1</sub> – pressure at cal point 1 in PSI.(Older Umac systems only)

P<sub>2</sub> – pressure at cal point 2 in PSI.

P<sub>R-Cal</sub> - pressure at R-Cal (80%) in PSI.

P<sub>FS</sub> - pressure full-scale value.



Raw Materials

Verification  
 $C = \frac{(MFR)_{lab}}{(MFR)_{ps}}$

Pressure & Temperature

Sustainability



Material Analysis



Profitability

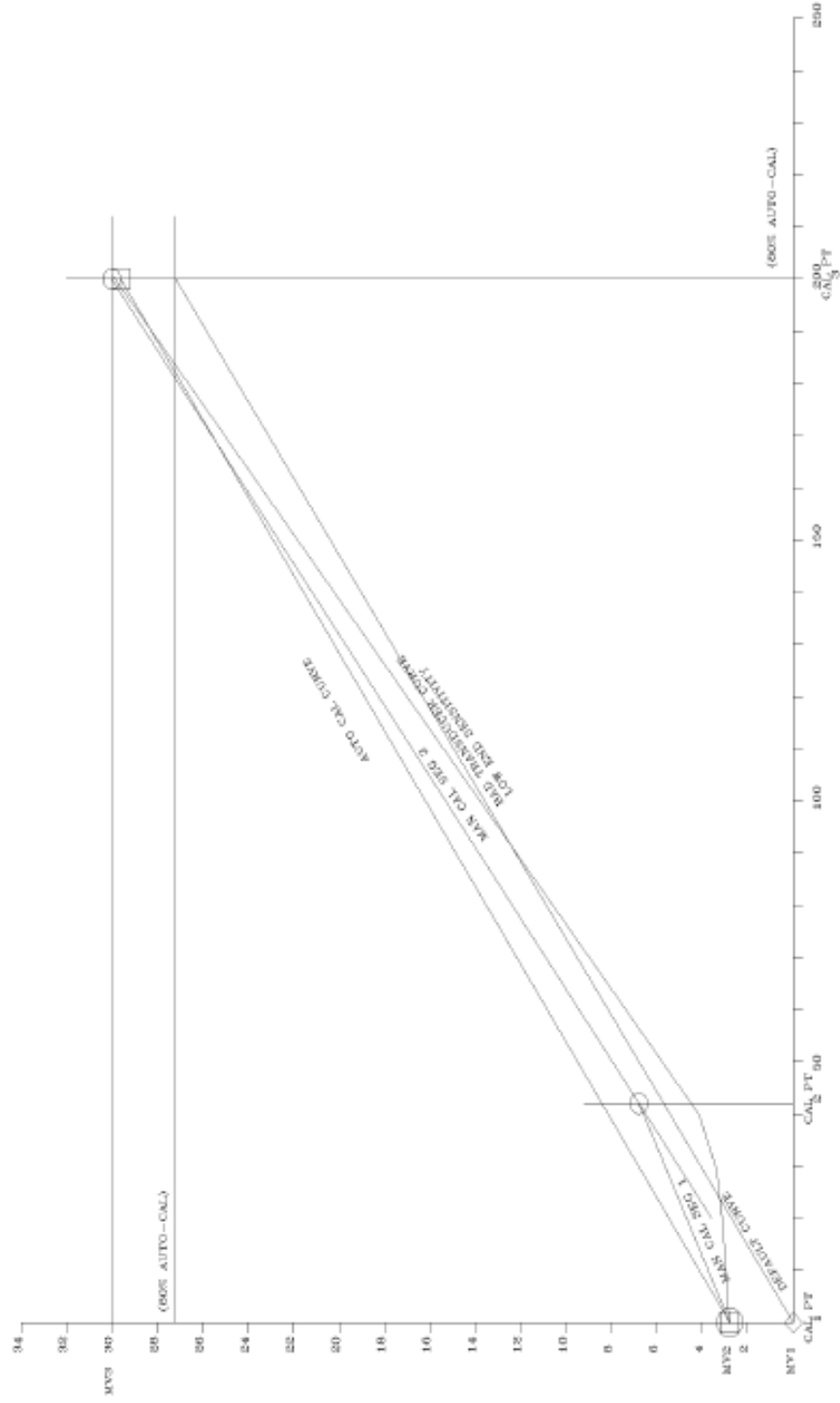

FIGURE VI-1 TRANSDUCER CURVES



The “auto-cal” curve uses a precision resistor etched on the sensing diaphragm of the pressure transducer to produce an electrical signal equal to 80% of the full scale millivolt output. DYNISCO recommends that the automatic calibration feature only be used after the linearity of the pressure transducer has been verified using the pressure standard. Auto calibration does not check the condition of the sensing diaphragm.

The manual calibration allows the technician to put one, two or three known pressures on the diaphragm of the transducer.

NOTE: IF THE TEST TEMPERATURE IS CHANGED MORE THAN +/- 20 C, RECALIBRATE / ZERO SHIFT THE TRANSDUCERS.

#### Changing the Transducer Range

The Rheology Measurement System has the ability to operate using different pressure transducer ranges. This increases the systems flexibility because it allows the client to use low pressure transducers for MFI measurements and then change to higher pressure transducers for viscosity measurements.

On the HMI, go to the pressure calibration screen for the transducer (screen 230-2) and set the Max Pressure for the given transducer. Refer to section Local Operator Display.

#### Automatic Calibration

When the AUTOMATIC CALIBRATION mode is selected, a "Span" pressure of 80% of the transducer full scale value automatically is entered into the CPU. When Automatic Cal is executed, the CPU reads the millivolt output of the pressure transducer at atmosphere and records this value. Next, the CPU closes the SPAN relay which places a calibrated resistance in parallel with one leg of the transducer strain gauge. This produces a millivolt signal equal to 80% of the pressure transducer output. This millivolt value is recorded as the span millivolts. The CPU calculates the transducer pressure by converting the transducer millivolts to a pressure using the millivolts at 0 (zero) PSI and the span millivolts at the span pressure.

$$P_{\text{Reading}} = \frac{(E_{\text{Meas}} - E_0)}{E_{\text{RCal}}} * P_{\text{RCal}}$$

**NOTE: The pressure transducer must be at atmospheric pressure before performing an Automatic Cal!**

Each transducer is calibrated individually. Perform the automatic calibration with the heat ON and no temperature errors or warnings. After a successful automatic calibration, Auto will be displayed as the transducer cal method on the pressure calibration screen



## Manual Calibration

The MANUAL CALIBRATION function allows the maintenance technician to place a known pressure on the diaphragms of the pressure transducers using a pressure standard such as a Dead Weight Tester. Two different pressures are required for a manual calibration. Each pressure transducer is calibrated individually.

1. Verify that the heat is ON and the unit is at test temperature.
2. Verify that the motor/pump is OFF.
3. Go to screen 230/1/2 Press Cal for the transducer that is to be calibrated.
4. Verify that the maximum pressure is set for the transducer in the calibration screen.
5. Close the inlet and outlet valves to isolate the process pressure from the rheometer.
6. Connect the dead weight test (DWT) and open the DWT to atmosphere (0.0 PSI).
7. On the HMI, enter the DWT pressure (0.0 PSI) as the point 1 pressure.
8. When the actual mV value displayed on the HMI has stabilized, enter the mV value as the point 1 mV value.
9. Apply the second calibration pressure (43.2 PSI).
10. On the HMI, enter the DWT pressure (43.2 PSI) as the point 2 pressure.
11. When the actual mV value displayed on the HMI has stabilized, enter the mV value as the point 2 mV value.
12. Apply the third calibration pressure (200 PSI for a 250 PSI transducer).
13. On the HMI, enter the DWT pressure (200.0 PSI) as the point 3 pressure.
14. When the actual mV value displayed on the HMI has stabilized, enter the mV value as the point 3 mV value.
15. The Cal Method will display User.
16. Remove the DWT, cap the calibration port, and open the isolation valves.

## Pressure NULL

Due to aging of the transducers and electronic components, the maintenance technician can NULL or shift the manual cal transducer curves. Apply a known pressure (or open the system to atmosphere) and record the shift for each curve. This difference is used to shift each curve to the applied NULL pressure. All the transducers are nulled simultaneously.

1. Verify that the heat is ON and the unit is at test temperature.
2. Verify that the motor/pump is OFF.
3. Go to screen 230/1/2 Press Cal for the transducer that is to be calibrated.
4. Close the inlet and outlet valves to isolate the process pressure from the rheometer.
5. Connect the dead weight test (DWT) and apply the null pressure.
6. On the HMI, enter the DWT pressure as the null pressure.
7. On the HMI, press the NULL button to signal the CPU to accept all three transducer output voltages. The millivolt value is used to shift the calibration curve for each pressure transducer.
8. Remove the DWT, cap the calibration port, and open the isolation valves.





## Transducer Low-End Sensitivity

The bottom 10% of the transducer range is the most non-linear. Historically, most transducers fail due to a lack of low-end sensitivity. The low-end sensitivity can be quickly checked during the transducer calibration by comparing the transducer millivolt output at atmosphere and the first calibration pressure. Using a 250 psi transducer, 43.2 psi is approximately 17% of 250 psi. The expected full-scale millivolt output for the transducer is 33.3 millivolts, 17% of 33.33 millivolts is approximately 5 millivolts. In other word, you should see an increase of  $5 \pm 0.5$  millivolts in the recorded millivolt outputs from atmosphere and the first calibration pressure.

Example 1:      Output @ 0 psi 1.2 mv  
                    Output @ 43.2 psi 6.0 mv

Conclusion - good transducer.

Example 2:      Output @ 0 psi 1.2 mv  
                    Output @ 43.2 psi 4.5 mv

Conclusion - bad transducer.



## MOTOR SPEED CONTROLLER ADJUSTMENTS

The Motor Speed Controller input is 0 to 10 VDC from the CPU. The "Minimum" and "Maximum" adjustments are located on the isolation circuit board on the motor speed controller (see figure VI-2).

1. Go to screen 341 DIAG AO 1.
2. Select 0V for analog output 1. With a DVM, measure the input voltage to the MSC.
3. Select 5V for analog output 1. With a DVM, measure the input voltage to the MSC.
4. Select 10V for analog output 1. With a DVM, measure the input voltage to the MSC.
5. If necessary, go to screen 242 Ana Out Cal 1. Set the AO1 – (0-10 V) offset voltage such that the voltages measured in steps 2-4 are accurate +/- 0.01 V.
6. Verify the following jumper settings on the MSC isolation board:
  - 6.1. J6 0-10
7. Verify the following settings on the MSC main board:
  - 7.1. S1 up position
  - 7.2. J1 2.5A
  - 7.3. J3 proper voltage for unit (115/230 VAC to 90/180 VDC motor)
  - 7.4. J4/J5 proper voltage for unit
  - 7.5. ACCEL pot 50% (12 o'clock or vertical position)
  - 7.6. TORQUE pot 75% (2 o'clock position)
8. Program the Phoenix Contact F to V converter with the following values.
  - 8.1. Zero Input 0
  - 8.2. FS input 2580
  - 8.3. Analog Output 0-10 V
  - 8.4. Digital Output OFF
  - 8.5. SAVE
9. Disconnect the motor drive coupling!
10. Go to screen 348 DIAG-Motor.
11. Enter the following motor speed voltages on the HMI screen. With the motor ON, adjust the MIN and MAX pots on the MSC isolation board until the HMI shows the desired speed reading. At that time, the average of the F/V converter display will be the frequency shown below. Repeat until no pot adjustments are required.

11.1. Speed setting 0.25 V (adjust MIN pot)	57 Hz on F/V	1 RPM on HMI
11.2. Speed setting 10.0 V (adjust MAX pot)	2293 Hz on F/V	40 RPM on HMI

12. Return to screen 000 MAIN.

NOTE: on a 90 VDC motor 5RPM is about 13-14 VDC

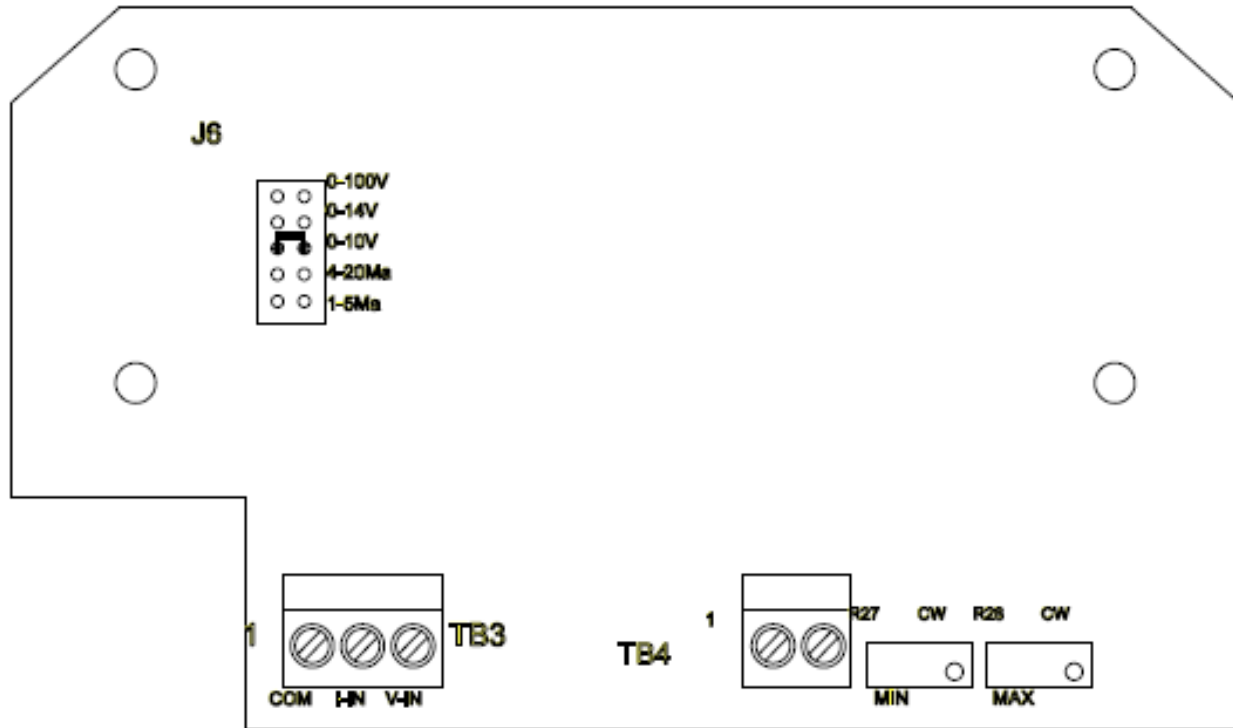

FIGURE VI-2 MOTOR SPEED CONTROLLER



## Strip Chart Output Level Test

1. Go to screen 341 DIAG AO 1.
2. For output 2 (SPEED), press the 4/12/20 mA button and verify the reading on the analog output. If necessary go to screen 242 Ana Out Cal 1 and set the offset value for the SPEED.
3. For output 3 (PT 1), press the 4/12/20 mA button and verify the reading on the analog output. If necessary go to screen 243 Ana Out Cal 2 and set the offset value for PT1.
4. For output 4 (PT 2), press the 4/12/20 mA button and verify the reading on the analog output. If necessary go to screen 243 Ana Out Cal 2 and set the offset value for PT2.
5. Go to screen 342 DIAG AO 2 that displays outputs 5-8.
6. For output 5 (PT 3), press the 4/12/20 mA button and verify the reading on the analog output. If necessary go to screen 244 Ana Out Cal 3 and set the offset value for PT3.
7. For output 6 (Melt average), press the 4/12/20 mA button and verify the reading analog output. If necessary go to screen 244 Ana Out Cal 3 and set the offset value for the Melt Average.
8. Return to screen 000 MAIN.

## Temperature Calibration

The temperature of the polymer melt is critical to achieve proper results. DYNISCO uses grade A RTD's for important temperature measurements and the client should also order grade A RTD's to use as spare parts. Along with the sensor, the associated electronics need to be checked to ensure the accuracy of the measurement.

There are two methods to test and calibrate the rheometer temperatures. Use a controlled temperature bath to validate the probe, field wiring, and the electronics. Use a probe simulator to validate the field wiring and electronics. The procedure is the same for each method.

1. Go to screen 210 Temp Cal. Enter the temperature offset such that the displayed calibrated value is accurate.
2. Wait while the displayed temperature stabilizes.